

For more, please visit our website: [www.cmeclock.com](http://www.cmeclock.com)

# YellowGate Entry System<sup>®</sup>

2017  
CATALOG ▶



YellowGate Entry System<sup>®</sup>  
belongs to  
CMEC Group

## YellowGate Entry System®

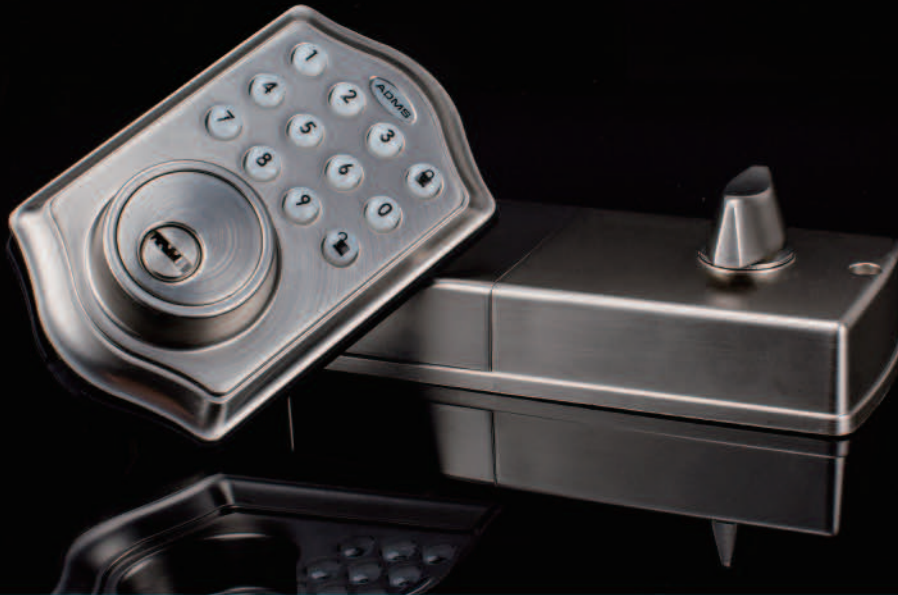

\*ECL-01

**Yellowgate Entry System** is a brand, which is registered in the U.S., of **CMEC Group**. China Machine Engineering SUZHOU Co., Ltd(CMEC SUZHOU)is established in 1987. In 2012, CMEC was listed on the Hong Kong StockExchange. CMEC Group has been in lock market since 1997. As a Leading state-owned company, we are committed to presenting our customers with the best lock body, padlock, rim lock and electric lock.



### ● **Leading Status**

We are the top 5 Manufacturer of lock in China and the biggest on in East China. We have the whole industry chain including Stamping, Casting, Galvanizing, Chroming and Waste Treatment. The waste treatment reflect corporate social responsibility.

### ● **Engineering Capabilities**

We have a dedicated R&D and Engineering team to support and to serve our customer's needs. There are more than 200 Engineers, 5000 Experienced Worker in our company.

### ● **Production Capabilities**

We've established a business network including more than 80 countries and regions around the world. We serve original equipment manufacturer, institutional and industrial customers, professional installers, as well as globe and national-wide retail chains.

### ● **Quality Assurance**

As an ISO9001:2008 certified manufacturer, we have implemented the total quality assurance system from raw material inspection, production processing control, to final inspection and packaging.

### ● **Chairman Statement**

Based on the corporate philosophy of "Create Ideas, Achieve Dreams" and the corporate culture of "Diversity, Tolerance and Innovation", CMEC has accomplished many civil engineering projects in many parts of the world which mark the good will between China and its international friends. CMEC is always striving to retain its leading position through its capacities in marketing, business operation, financing, project management, resource management and R&D, all in an international context.



■ **ECL-01**



- One-Touch to Lock The Door
- One-Time Guest Code Is Availibale
- Indicator Light to Indicate Unlock, Lock and Wrong Code
- Can Set Fifty 4-10 Digit Codes
- Turn Button to Lockset form Interior



■ **ECL-01**



- One-Touch to Lock The Door
- One-Time Guest Code Is Availibale
- Indicator Light to Indicate Unlock, Lock and Wrong Code
- Can Set Fifty 4-10 Digit Codes
- Turn Button to Lockset form Interior



**■ BB.72.50MR**

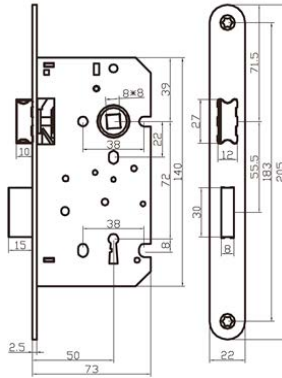

Backset: 50 mm  
 Center Distance: 72 mm  
 Latch Bolt: 27 mm Zinc Alloy  
 Dead Bolt: 30 mm Iron  
 Knob: Nylon + Iron  
 Lever Handle Spindle: 8\*8 mm Square  
 Key: Zinc Alloy/ Nickel Plating

**■ PZ72.50MR**

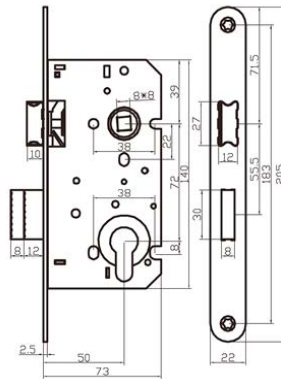

Backset: 50 mm  
 Center Distance: 72 mm  
 Latch Bolt: 27 mm Zinc Alloy  
 Dead Bolt: 30 mm Iron  
 Knob: Nylon + Iron  
 Lever Handle Spindle: 8\*8 mm Square

**■ LB.50S'55S'60S**

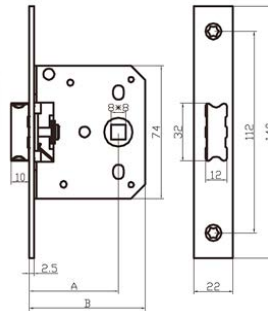

A	50	55	60
B	65	70	75

Backset: 50/55/60 mm  
 Latch Bolt: 32 mm Zinc Alloy  
 Knob: Nylon + Iron  
 Lever Handle Spindle: 8\*8 mm Square

**■ BB72.50S'55S'60S**

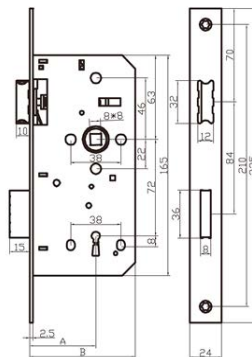

A	50	55	60
B	80	85	90

Backset: 50/55/60 mm  
 Center Distance: 72 mm  
 Latch Bolt: 32 mm Zinc Alloy  
 Dead Bolt: 36 mm Iron  
 Knob: Nylon + Iron  
 Lever Handle Spindle: 8\*8 mm Square  
 Key: Zinc Alloy/ Nickel Plating



■ **PZ72.50S'55S**

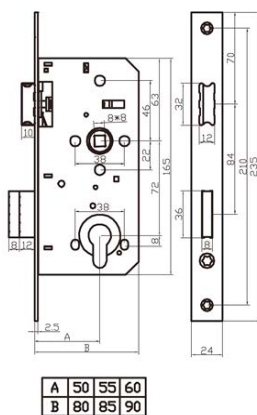

Backset: 50/55/60 mm  
 Center Distance: 72 mm  
 Latch Bolt: 32 mm Zinc Alloy  
 Dead Bolt: 36 mm Iron  
 Knob: Nylon + Iron  
 Lever Handle Spindle: 8\*8 mm Square

■ **WC78.50S'55S**

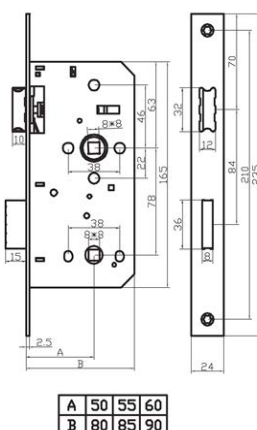

Backset: 50/55/60 mm  
 Center Distance: 78 mm  
 Latch Bolt: 32 mm Zinc Alloy  
 Dead Bolt: 36 mm Iron  
 Knob: Nylon + Iron  
 Lever Handle Spindle: 8\*8 mm Square  
 Thumb Turn Spindle: 8\*8 mm Square

■ **BB110.50R'55R'60R**

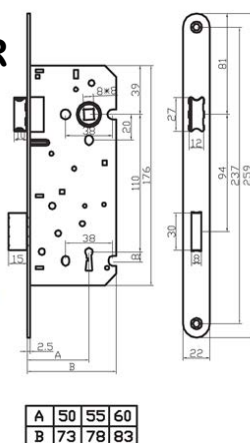

Backset: 50/55/60 mm  
 Center Distance: 110 mm  
 Latch Bolt: 27 mm Zinc Alloy  
 Dead Bolt: 30 mm Iron  
 Knob: Nylon + Iron  
 Lever Handle Spindle: 8\*8 mm Square  
 Key: Zinc Alloy/ Nickel Plating

■ **PZ110.50R'55R'60R**

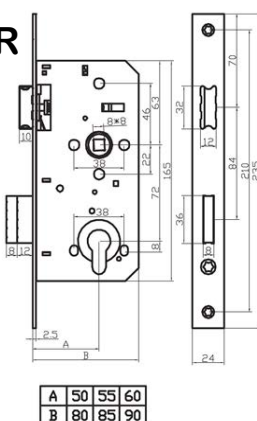

Backset: 50/55/60 mm  
 Center Distance: 72 mm  
 Latch Bolt: 32 mm Zinc Alloy  
 Dead Bolt: 36 mm Iron  
 Knob: Nylon + Iron  
 Lever Handle Spindle: 8\*8 mm Square



**■ PZ90.50R**

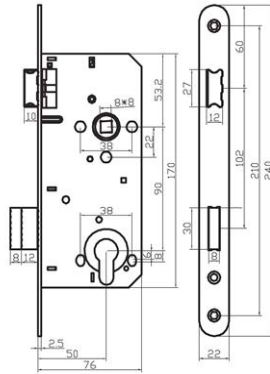

Backset: 50 mm  
 Center Distance: 90 mm  
 Latch Bolt: 27 mm Zinc Alloy  
 Dead Bolt: 30 mm Iron  
 Knob: Nylon + Iron  
 Lever Handle Spindle: 8\*8 mm Square



**■ BB90.50R**

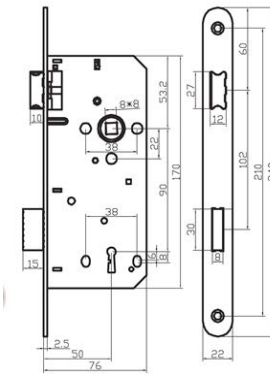

Backset: 50 mm  
 Center Distance: 90 mm  
 Latch Bolt: 27 mm Zinc Alloy  
 Dead Bolt: 30 mm Iron  
 Knob: Nylon + Iron  
 Lever Handle Spindle: 8\*8 mm Square  
 Key: Zinc Alloy/ Nickel Plating



**■ WC90.50R**

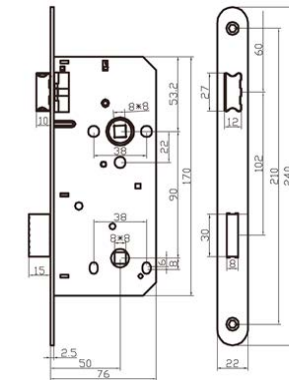

Backset: 50 mm  
 Center Distance: 90 mm  
 Latch Bolt: 27 mm Zinc Alloy  
 Dead Bolt: 30 mm Iron  
 Knob: Nylon + Iron  
 Lever Handle Spindle: 8\*8 mm Square  
 Thumb Turn Spindle: 8\*8 mm Square



**■ WC116.50S'55S'60S**

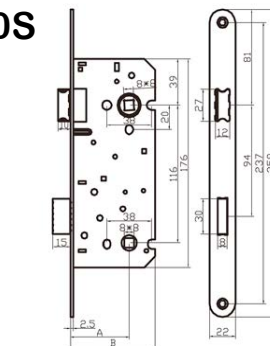

Backset: 50/55/60 mm  
 Center Distance: 116 mm  
 Latch Bolt: 27 mm Zinc Alloy  
 Dead Bolt: 30 mm Iron  
 Knob: Nylon + Iron  
 Lever Handle Spindle: 8\*8 mm Square  
 Thumb Turn Spindle: 8\*8 mm Square

A	50	55	60
B	73	78	83



■ **Z7504B-C**

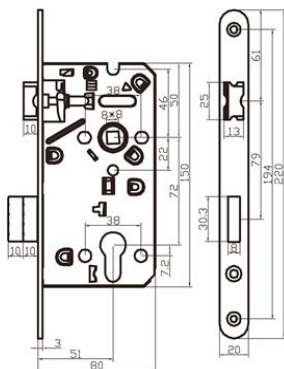

Backset: 51 mm  
 Center Distance: 72 mm  
 Latch Bolt: 25 mm Aluminum  
 Dead Bolt: 30.3 mm Aluminum  
 Knob: Metal Worked Sheet Iron  
 Lever Handle Spindle: 8\*8 mm Square

■ **Z7504C-B**

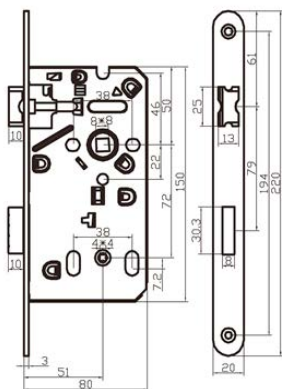

Backset: 51 mm  
 Center Distance: 72 mm  
 Latch Bolt: 25 mm Aluminum  
 Dead Bolt: 30.3 mm Aluminum  
 Knob: Metal Worked Sheet Iron  
 Lever Handle Spindle: 8\*8 mm Square  
 Thumb Turn Spindle: 4\*4 mm Square

■ **Z7504Z-K**

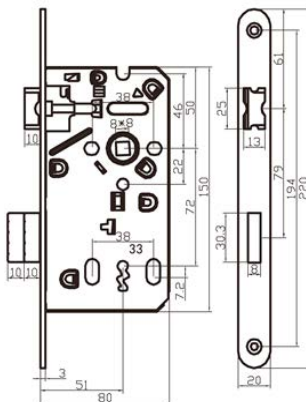

Backset: 51 mm  
 Center Distance: 72 mm  
 Latch Bolt: 25 mm Aluminum  
 Dead Bolt: 30.3 mm Aluminum  
 Knob: Metal Worked Sheet Iron  
 Lever Handle Spindle: 8\*8 mm Square  
 Key: Zinc Alloy/ Nickel Plating

■ **ZT95**

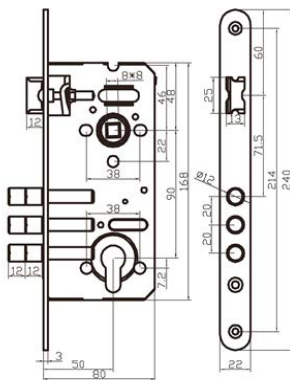

Backset: 50 mm  
 Center Distance: 90 mm  
 Latch Bolt: 25 mm Aluminum  
 Dead Bolt: Triple Db12 mm Iron  
 Knob: Metal Worked Sheet Iron  
 Lever Handle Spindle: 8\*8 mm Square



**Z755B-C**

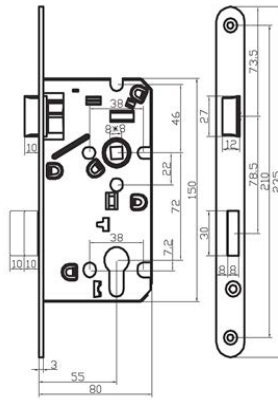

Backset: 55 mm  
 Center Distance: 72 mm  
 Latch Bolt: 27 mm Aluminum  
 Dead Bolt: 30 mm Aluminum  
 Knob: Metal Worked Sheet Iron  
 Lever Handle Spindle: 8\*8 mm Square



**Z755C-B**

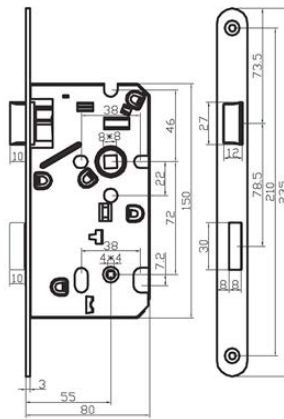

Backset: 55 mm  
 Center Distance: 72 mm  
 Latch Bolt: 27 mm Aluminum  
 Dead Bolt: 30 mm Aluminum  
 Knob: Metal Worked Sheet Iron  
 Lever Handle Spindle: 8\*8 mm Square  
 Thumb Turn Spindle 4\*4 mm Square



**Z755Z-K**

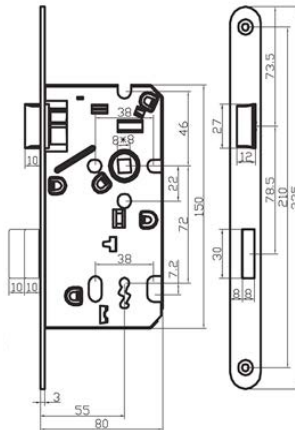

Backset: 55 mm  
 Center Distance: 72 mm  
 Latch Bolt: 27 mm Aluminum  
 Dead Bolt: 30 mm Aluminum  
 Knob: Metal Worked Sheet Iron  
 Lever Handle Spindle: 8\*8 mm Square  
 Key: Zinc Alloy/ Nickel Plating



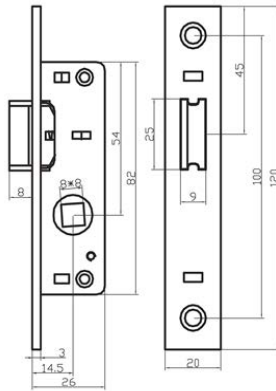

Backset: 14.5 mm  
 Latch Bolt: 25 mm Copper  
 Knob: Powder Metallurgy Iron  
 Lever Handle Spindle: 8\*8 mm Square

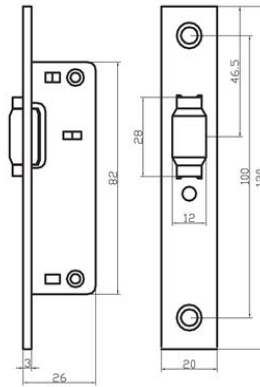

Lock Ball: 28 mm Copper

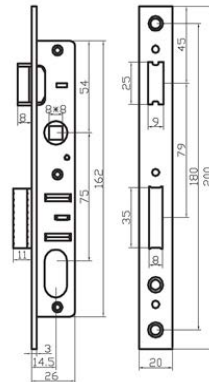

Backset: 14.5 mm  
 Center Distance: 75 mm  
 Latch Bolt: 25 mm Copper  
 Dead Bolt: 30 mm Copper  
 Knob: Powder Metallurgy Iron  
 Lever Handle Spindle: 8\*8 mm Square

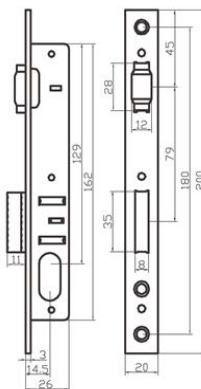

Backset: 14.5 mm  
 Lock Ball: 28 mm Copper  
 Dead Bolt: 30 mm Copper

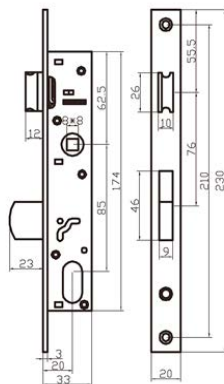

Backset: 20 mm  
 Center Distance: 85 mm  
 Latch Bolt: 26 mm Copper  
 Dead Bolt: Zinc Alloy  
 Knob: Powder Metallurgy Iron  
 Lever Handle Spindle: 8\*8 mm Square

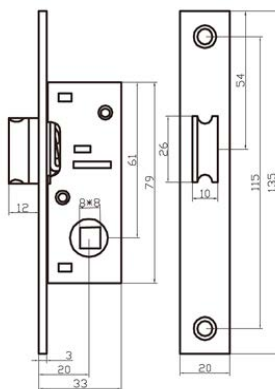

Backset: 20 mm  
 Latch Bolt: 26 mm Copper  
 Knob: Powder Metallurgy Iron  
 Lever Handle Spindle: 8\*8 mm Square

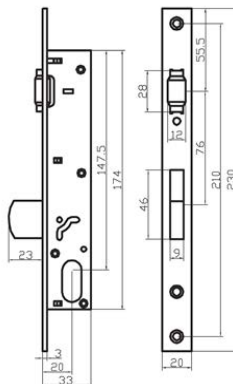

Backset: 20 mm  
 Lock Ball: 28 mm Copper  
 Dead Bolt: Zinc Alloy

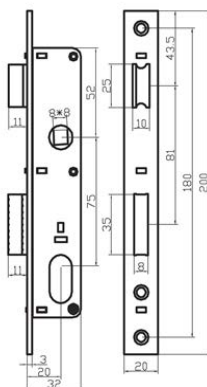

Backset: 20 mm  
 Center Distance: 75 mm  
 Latch Bolt: 25 mm Copper  
 Dead Bolt: 35 mm Copper  
 Knob: Zinc Iron  
 Lever Handle Spindle: 8\*8 mm Square



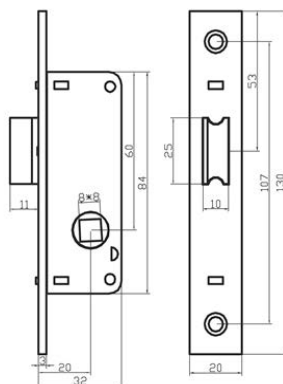

Backset: 20 mm  
 Latch Bolt: 25 mm Copper  
 Knob: Zinc Zinc Alloy  
 Lever Handle Spindle: 8\*8 mm Square

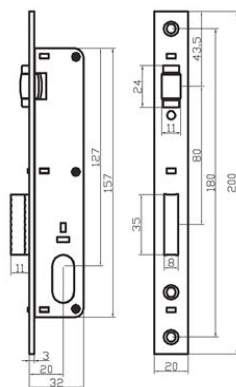

Backset: 20 mm  
 Lock Ball: 24 mm Copper  
 Dead Bolt: 35 mm Copper

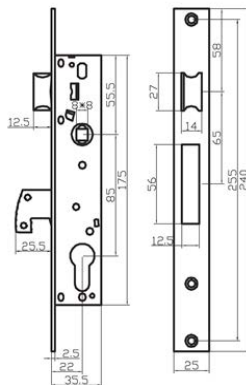

Backset: 22 mm  
 Center Distance: 85 mm  
 Latch Bolt: 27 mm Zinc Alloy  
 Dead Bolt: Stainless Steel  
 Knob: Zinc Alloy  
 Lever Handle Spindle: 8\*8 mm Square

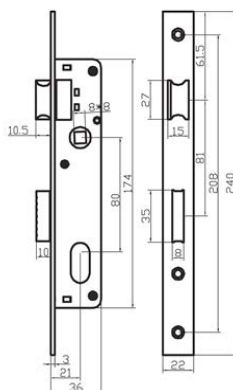

Backset: 21 mm  
 Center Distance: 80 mm  
 Latch Bolt: 27 mm Zinc Alloy  
 Dead Bolt: 35 mm Copper

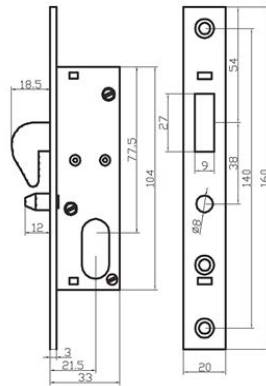

Backset: 21.5 mm  
 Dead Bolt: Powder Metallurgy Iron

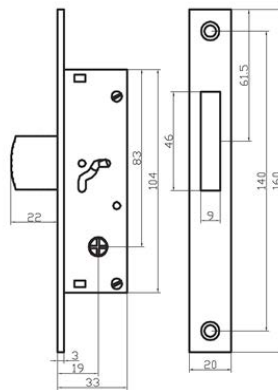

Backset: 19 mm  
 Dead Bolt: Powder Metallurgy Iron

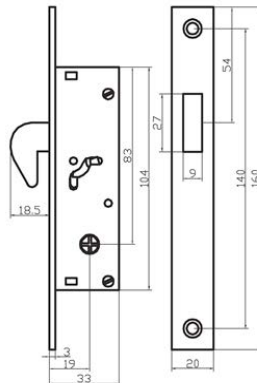

Backset: 19 mm  
 Dead Bolt: Powder Metallurgy Iron



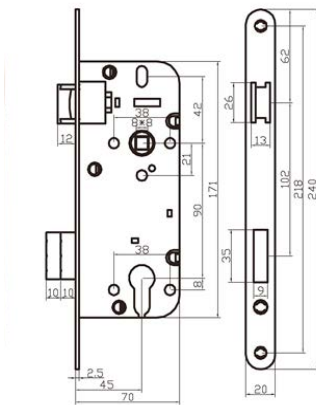

Backset: 45 mm  
 Center Distance: 90 mm  
 Latch Bolt: 26 mm Zinc Alloy  
 Dead Bolt: 35 mm Iron  
 Knob: Zinc Alloy  
 Lever Handle Spindle: 8\*8 mm Square

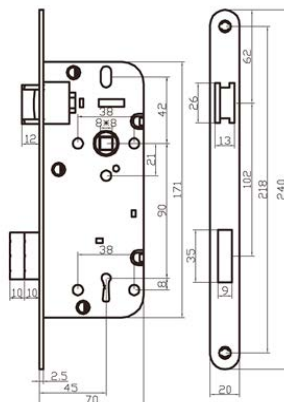

Backset: 45 mm  
 Center Distance: 90 mm  
 Latch Bolt: 26 mm Zinc Alloy  
 Dead Bolt: 35 mm Iron  
 Knob: Zinc Alloy  
 Lever Handle Spindle: 8\*8 mm Square  
 Key: Zinc Alloy/ Nickel Plating

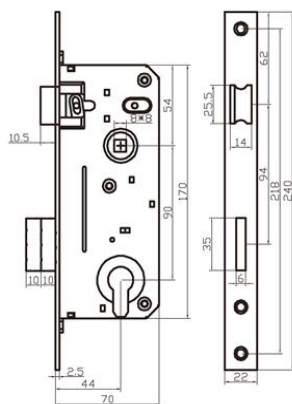

Backset: 45 mm  
 Center Distance: 90 mm  
 Latch Bolt: 25.5 mm Zinc Alloy  
 Dead Bolt: 35 mm Zinc Alloy  
 Knob: Zinc Alloy  
 Lever Handle Spindle: 8\*8 mm Square

■ **JG01C**

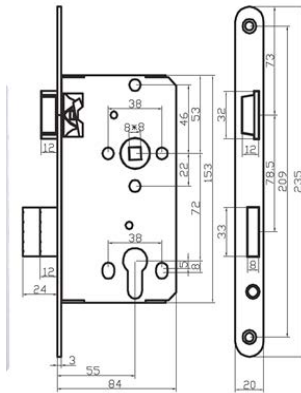

Backset: 55 mm  
 Center Distance: 72 mm  
 Latch Bolt: 32 mm Zinc Alloy  
 Dead Bolt: 33 mm Zinc Alloy  
 Knob: Zinc Alloy  
 Lever Handle Spindle: 8\*8 mm Square

■ **JG01K**

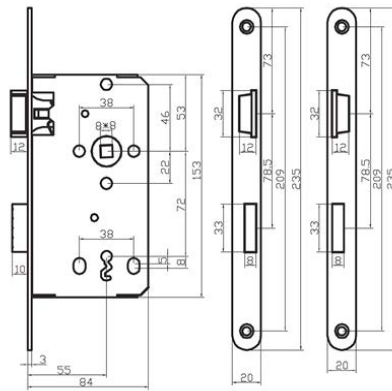

Backset: 45 mm  
 Center Distance: 90 mm  
 Latch Bolt: 25.5 mm Zinc Alloy  
 Dead Bolt: 35 mm Zinc Alloy  
 Knob: Zinc Alloy  
 Lever Handle Spindle: 8\*8 mm Square

■ **1740**

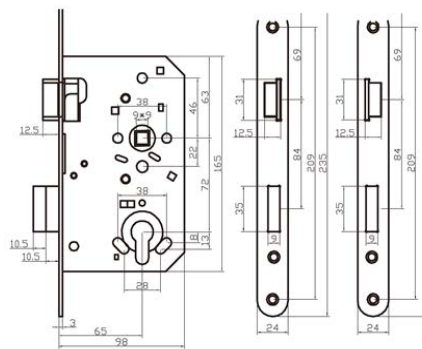

Backset: 65 mm  
 Center Distance: 72 mm  
 Latch Bolt: 31 mm Cast Iron  
 Dead Bolt: 35 mm Cast Iron  
 Knob: Iron  
 Lever Handle Spindle: 9\*9 mm Square

■ **1740-1**

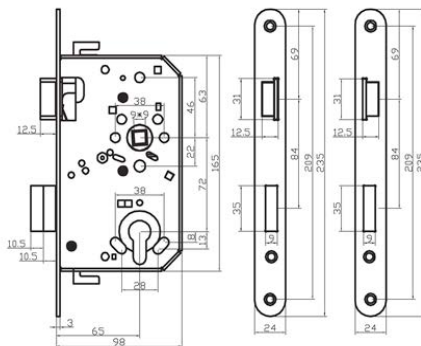

Backset: 65 mm  
 Center Distance: 72 mm  
 Latch Bolt: 31 mm Cast Iron  
 Dead Bolt: 35 mm Cast Iron  
 Knob: Iron  
 Lever Handle Spindle: 9\*9 mm Square



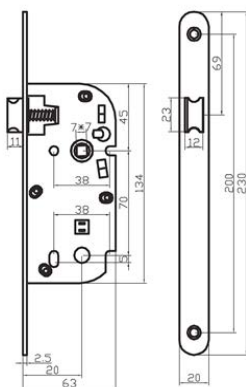

Backset: 20 mm  
 Latch Bolt: 23 mm Zinc Alloy  
 Knob: Zinc Alloy  
 Lever Handle Spindle: 8\*8 mm Square

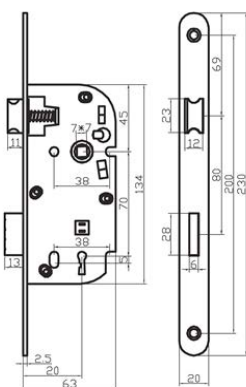

Backset: 20 mm  
 Center Distance: 70 mm  
 Latch Bolt: 23 mm Zinc Alloy  
 Dead Bolt: 28 mm Iron  
 Knob: Zinc Alloy  
 Lever Handle Spindle: 7\*7 mm Square  
 Key: Zinc Alloy/ Nickel Plating

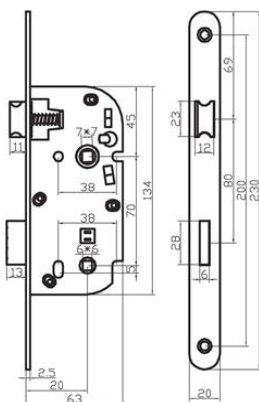

Backset: 20 mm  
 Center Distance: 70 mm  
 Latch Bolt: 23 mm Zinc Alloy  
 Dead Bolt: 28 mm Iron  
 Knob: Zinc Alloy  
 Lever Handle Spindle: 7\*7 mm Square  
 Thumb Turn Spindle: 6\*6 mm Square

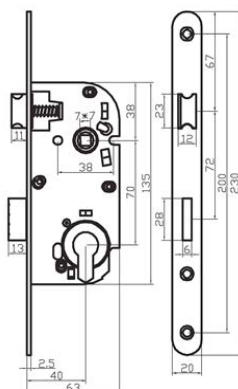

Backset: 40 mm  
 Center Distance: 70 mm  
 Latch Bolt: 23 mm Zinc Alloy  
 Dead Bolt: 28 mm Iron  
 Knob: Zinc Alloy  
 Lever Handle Spindle: 7\*7 mm Square



■ **5100**

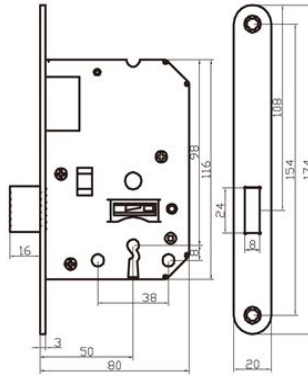

Backset: 50 mm  
 Dead Bolt: 24 mm Zinc Alloy  
 Key: Zinc Alloy/ Nickel Plating

■ **5150**

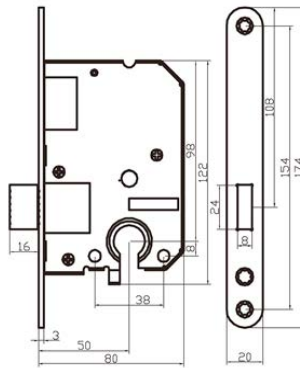

Backset: 50 mm  
 Dead Bolt: 24 mm Zinc Alloy

■ **5002**

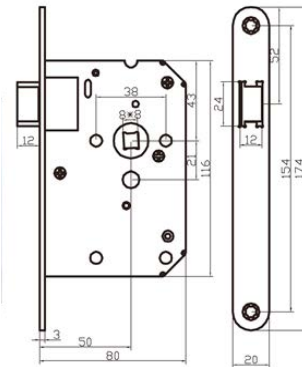

Backset: 50 mm  
 Latch Bolt: 24 mm Zinc Alloy  
 Knob: Zinc Alloy  
 Lever Handle Spindle: 8\*8 mm Square

■ **5202**

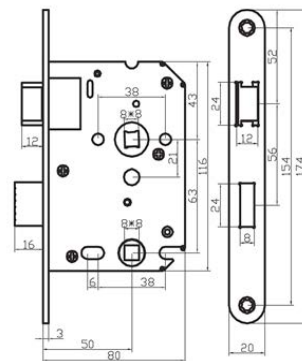

Backset: 50 mm  
 Center Distance: 116 mm  
 Latch Bolt: 24 mm Zinc Alloy  
 Dead Bolt: 24 mm Iron  
 Knob: Zinc Alloy  
 Lever Handle Spindle: 8\*8 mm Square  
 Thumb Turn Spindle: 8\*8 mm Square

■ **5300**

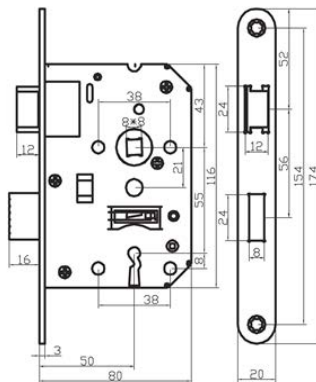

- Backset: 50 mm
- Center Distance: 55 mm
- Latch Bolt: 24 mm Zinc Alloy
- Dead Bolt: 24 mm Zinc Alloy
- Knob: Zinc Alloy
- Lever Handle Spindle: 8\*8 mm Square
- Key: Zinc Alloy/ Nickel Plating

■ **5402**

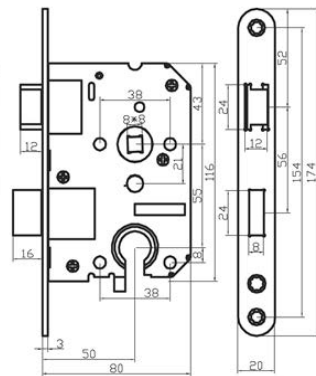

- Backset: 50 mm
- Center Distance: 55 mm
- Latch Bolt: 24 mm Zinc Alloy
- Dead Bolt: 24 mm Zinc Alloy
- Knob: Zinc Alloy
- Lever Handle Spindle: 8\*8 mm Square

■ **1008**

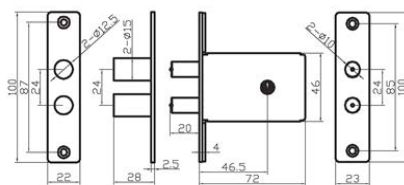

- Backset: 46.5 mm
- Dead Bolt: Double Db15 mm Iron

■ **725**

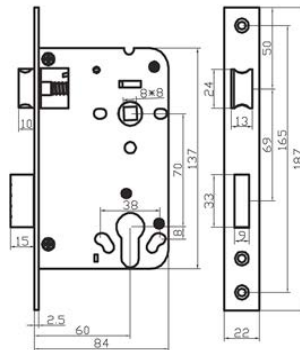

Backset: 60 mm  
 Center Distance: 70 mm  
 Latch Bolt: 24 mm Zinc Alloy  
 Dead Bolt: 33 mm Zinc Alloy  
 Knob: Zinc Alloy  
 Lever Handle Spindle: 8\*8 mm Square

■ **725-1**

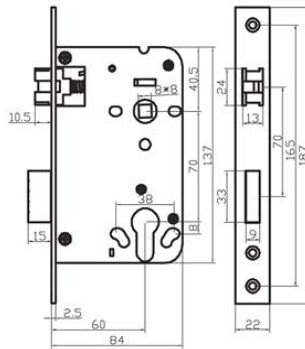

Backset: 60 mm  
 Center Distance: 70 mm  
 Latch Bolt: 24 mm Zinc Alloy  
 Dead Bolt: 33 mm Zinc Alloy  
 Knob: Zinc Alloy  
 Lever Handle Spindle: 8\*8 mm Square

■ **716**

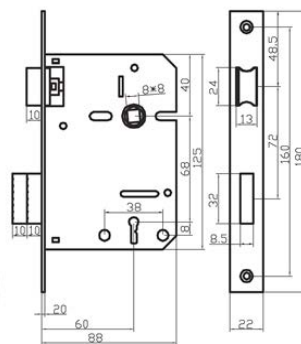

Backset: 60 mm  
 Center Distance: 68 mm  
 Latch Bolt: 24 mm Zinc Alloy  
 Dead Bolt: 32 mm Zinc Alloy  
 Knob: Zinc Alloy  
 Lever Handle Spindle: 8\*8 mm Square  
 Key: Zinc Alloy/ Nickel Plating

■ **716S**

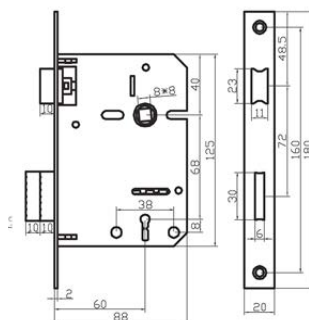

Backset: 60 mm  
 Center Distance: 68 mm  
 Latch Bolt: 23 mm Zinc Alloy  
 Dead Bolt: 30 mm Zinc Alloy  
 Knob: Zinc Alloy  
 Lever Handle Spindle: 8\*8 mm Square  
 Key: Zinc Alloy/ Nickel Plating



■ **3045**

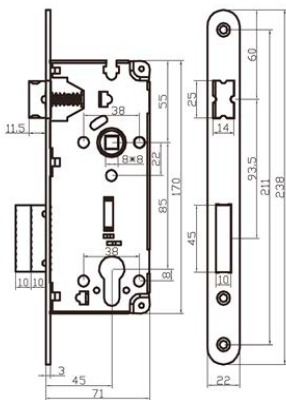

Backset: 45 mm  
 Center Distance: 85 mm  
 Latch Bolt: 25 mm Zinc Alloy  
 Dead Bolt: 45 mm Iron  
 Knob: Zinc Alloy  
 Lever Handle Spindle: 8\*8 mm Square



■ **3075**

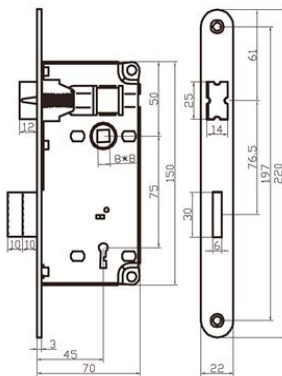

Backset: 45 mm  
 Center Distance: 75 mm  
 Latch Bolt: 25 mm Zinc Alloy  
 Dead Bolt: 30 mm Iron  
 Knob: Zinc Alloy  
 Lever Handle Spindle: 8\*8 mm Square  
 Key: Zinc Alloy/ Nickel Plating



■ **4120B**

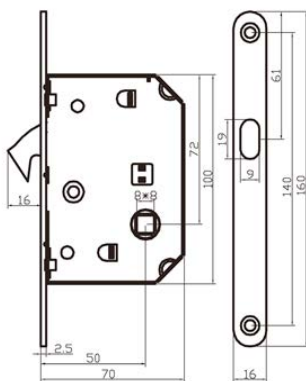

Backset: 50 mm  
 Dead Bolt: Zinc Alloy  
 Knob: Zinc Alloy  
 Lever Handle Spindle: 8\*8 mm Square



■ **4120K**

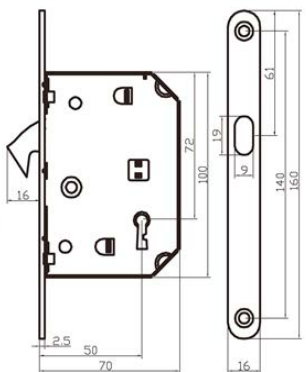

Backset: 50 mm  
 Dead Bolt: Zinc Alloy  
 Key: Zinc Alloy/ Nickel Plating



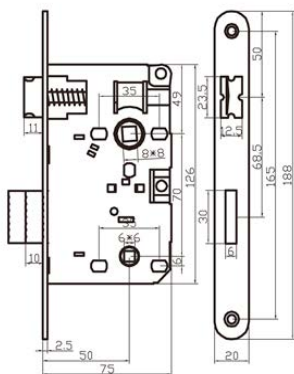

Backset: 50 mm  
 Center Distance: 70 mm  
 Latch Bolt: 23.5 mm Zinc Alloy  
 Dead Bolt: 30 mm Iron  
 Knob: Zinc Alloy  
 Lever Handle Spindle: 8\*8 mm Square  
 Thumb Turn Spindle: 6\*6 mm Square

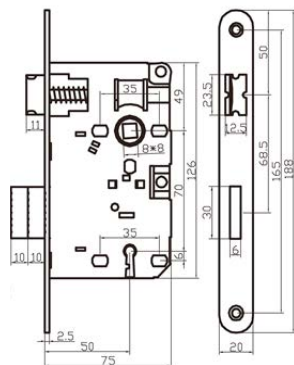

Backset: 50 mm  
 Center Distance: 70 mm  
 Latch Bolt: 23.5 mm Zinc Alloy  
 Dead Bolt: 35 mm Iron  
 Knob: Zinc Alloy  
 Lever Handle Spindle: 8\*8 mm Square  
 Key: Zinc Alloy/ Nickel Plating

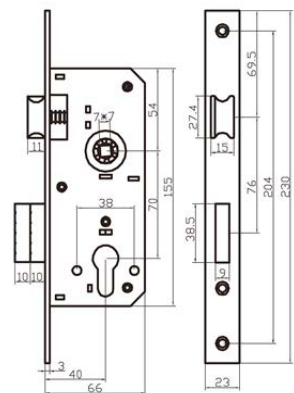

Backset: 40 mm  
 Center Distance: 70 mm  
 Latch Bolt: 27.4 mm Zinc Alloy  
 Dead Bolt: 38.5 mm Iron  
 Knob: Zinc Alloy  
 Lever Handle Spindle: 7\*7 mm Square

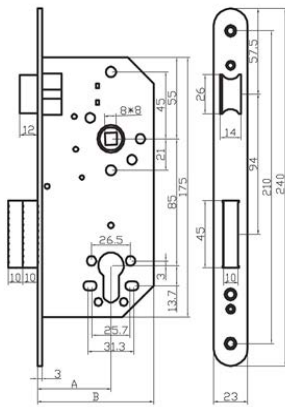

Backset: 40/45/50/60 mm  
 Center Distance: 85 mm  
 Latch Bolt: 26 mm Zinc Alloy  
 Dead Bolt: 45 mm Iron  
 Knob: Zinc Alloy  
 Lever Handle Spindle: 8\*8 mm Square

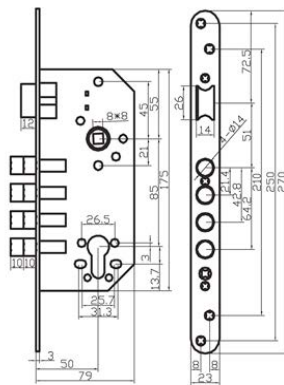
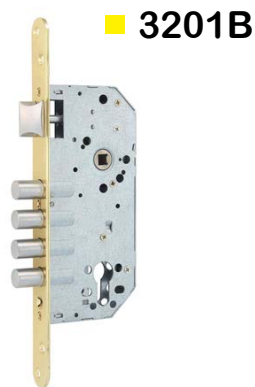

Backset: 50 mm  
 Center Distance: 85 mm  
 Latch Bolt: 26 mm Zinc Alloy  
 Dead Bolt: Quadruple Db14 mm Iron  
 Knob: Zinc Alloy  
 Lever Handle Spindle: 8\*8 mm Square

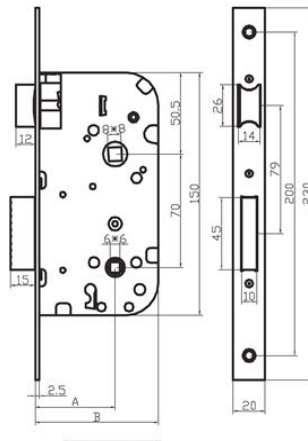

Backset: 40/50 mm  
 Center Distance: 70 mm  
 Latch Bolt: 26 mm Zinc Alloy  
 Dead Bolt: 45 mm Iron  
 Knob: Zinc Alloy  
 Lever Handle Spindle: 8\*8 mm Square  
 Thumb Turn Spindle: 6\*6 mm Square

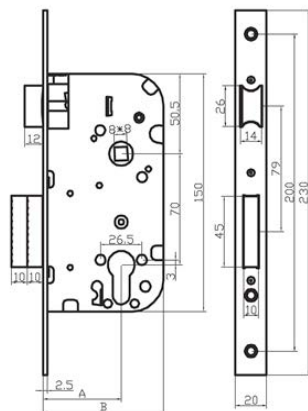

Backset: 40/50 mm  
 Center Distance: 70 mm  
 Latch Bolt: 26 mm Zinc Alloy  
 Dead Bolt: 45 mm Iron  
 Knob: Zinc Alloy  
 Lever Handle Spindle: 8\*8 mm Square

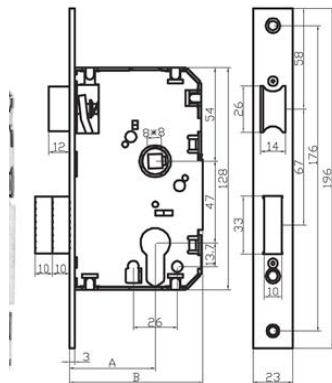

A	40	50	60
B	68	78	88

- Backset: 40/50/60 mm
- Center Distance: 47 mm
- Latch Bolt: 26 mm Zinc Alloy
- Dead Bolt: 33 mm Iron
- Knob: Zinc Alloy
- Lever Handle Spindle: 8\*8 mm Square

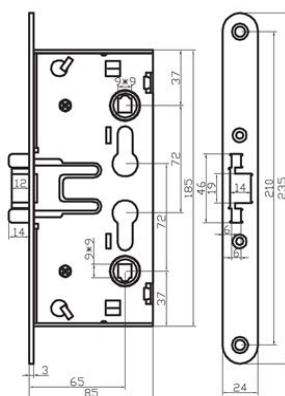

- Backset: 65 mm
- Latch Bolt: 19 mm Iron
- Latch Bolt: Double Iron Bolt
- Knob: Iron
- Lever Handle Spindle: Double 9\*9 mm Square
- Double Cylinder

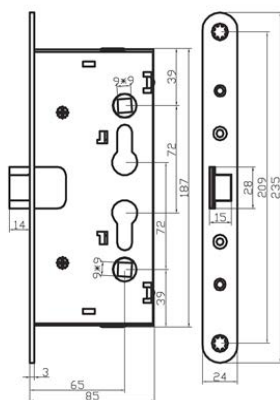

- Backset: 65 mm
- Latch Bolt: 28 mm Iron
- Knob: Iron
- Lever Handle Spindle: Double 9\*9 mm Square
- Double Cylinder

■ **LFB2**

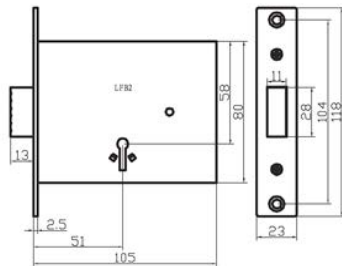

Backset: 51 mm  
 Dead Bolt: 28 mm Iron  
 Key: Zinc Alloy/ Nickel Plating

■ **PE47**

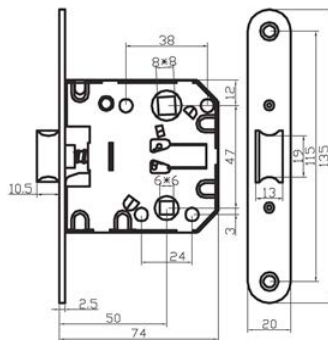

Backset: 50 mm  
 Center Distance: 47  
 Latch Bolt: 19 mm Zinc Alloy  
 Lever Handle Knob: Iron  
 Lever Handle Spindle: 8\*8 mm Square  
 Security Handle Knob: Zinc Alloy  
 Security Handle Spindle: 6\*6 mm Square

■ **PE47S**

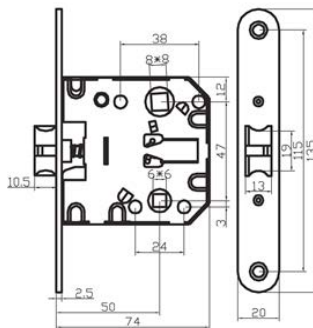

Backset: 50 mm  
 Center Distance: 47  
 Latch Bolt: 19 mm Zinc Alloy  
 Lever Handle Knob: Iron  
 Lever Handle Spindle: 8\*8 mm Square  
 Security Handle Knob: Zinc Alloy  
 Security Handle Spindle: 6\*6 mm Square



■ **PE70**

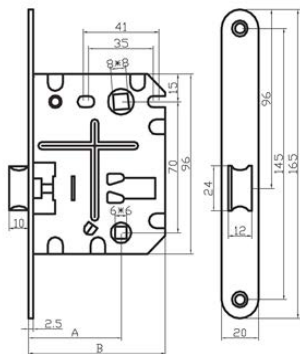

A	45	50
B	69	73

- Backset: 45/50 mm
- Center Distance: 70 mm
- Latch Bolt: 24 mm Zinc Alloy
- Lever Handle Knob: Iron
- Lever Handle Spindle: 8\*8 mm Square
- Security Handle Knob: Zinc Alloy
- Security Handle Spindle: 6\*6 mm Square

■ **PE70S**

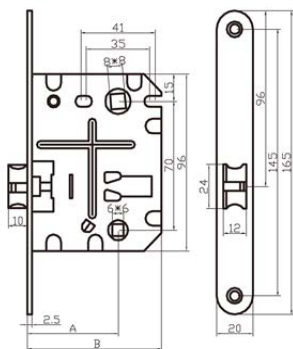

A	45	50
B	69	74

- Backset: 45/50 mm
- Center Distance: 70 mm
- Latch Bolt: 24 mm Zinc Alloy
- Lever Handle Knob: Iron
- Lever Handle Spindle: 8\*8 mm Square
- Security Handle Knob: Zinc Alloy
- Security Handle Spindle: 6\*6 mm Square

■ **6570**

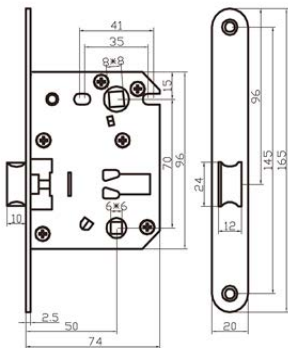

- Backset: 50 mm
- Center Distance: 70 mm
- Latch Bolt: 24 mm Zinc Alloy
- Lever Handle Knob: Iron
- Lever Handle Spindle: 8\*8 mm Square
- Security Handle Knob: Zinc Alloy
- Security Handle Spindle: 6\*6 mm Square

■ **SD410C-S-2**

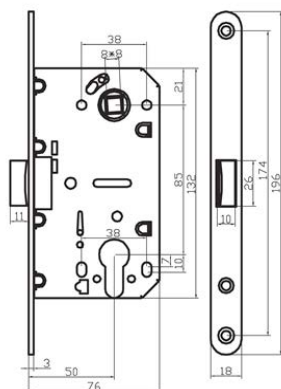

Backset: 50 mm  
 Center Distance: 85 mm  
 Latch Bolt: 26 mm Plastic  
 Knob: Zinc Alloy  
 Lever Handle Spindle: 8\*8 mm Square

■ **SD410B-S-2**

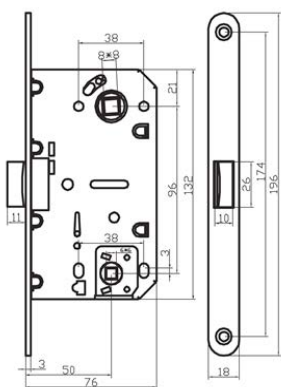

Backset: 50 mm  
 Center Distance: 96 mm  
 Latch Bolt: 26 mm Plastic  
 Knob: Zinc Alloy  
 Lever Handle Spindle: 8\*8 mm Square  
 Thumb Turn Spindle: 6\*6 mm Square

■ **SD410K-S-2**

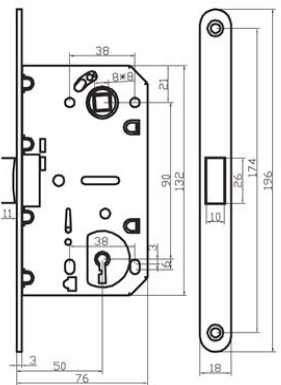

Backset: 50 mm  
 Center Distance: 90 mm  
 Latch Bolt: 26 mm Plastic  
 Knob: Zinc Alloy  
 Lever Handle Spindle: 8\*8 mm Square  
 Key: Zinc Alloy/ Nickel Plating



■ **9171B-2**

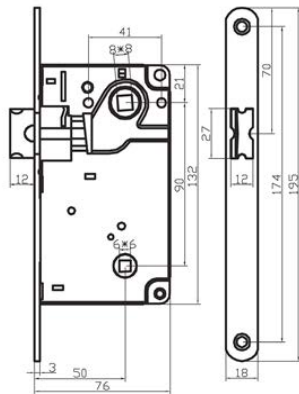

Backset: 50 mm  
 Center Distance: 90 mm  
 Latch Bolt: 27 mm Zinc Alloy  
 Knob: Zinc Alloy  
 Lever Handle Spindle: 8\*8 mm Square  
 Thumb Turn Spindle: 6\*6 mm Square



■ **9171C-2**

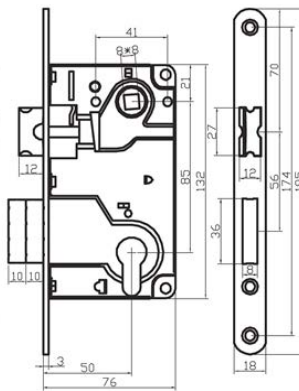

Backset: 50 mm  
 Center Distance: 85 mm  
 Latch Bolt: 27 mm Zinc Alloy  
 Dead Bolt: 36 mm Zinc Alloy  
 Knob: Zinc Alloy  
 Lever Handle Spindle: 8\*8 mm Square



■ **9171K-1**

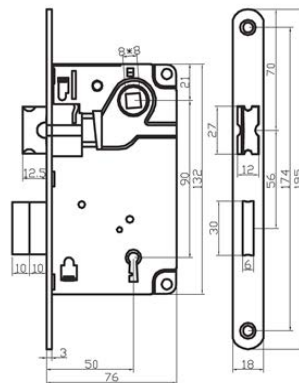

Backset: 50 mm  
 Center Distance: 90 mm  
 Latch Bolt: 27 mm Zinc Alloy  
 Dead Bolt: 30 mm Zinc Alloy  
 Knob: Zinc Alloy  
 Lever Handle Spindle: 8\*8 mm Square  
 Key: Zinc Alloy/ Nickel Plating



■ **9171KL-1**

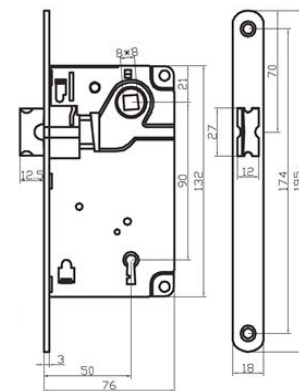

Backset: 50 mm  
 Center Distance: 90 mm  
 Latch Bolt: 27 mm Zinc Alloy  
 Knob: Zinc Alloy  
 Lever Handle Spindle: 8\*8 mm Square  
 Key: Zinc Alloy/ Nickel Plating

■ **257L**

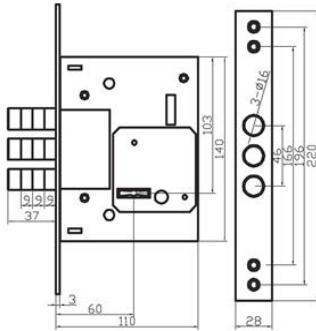

Backset: 60 mm  
 Dead Bolt: Triple Db16 mm Iron  
 Knob: Zinc Alloy  
 Flat Tumbler: Iron  
 Key: Copper/ Nickel Plating

■ **257L-C**

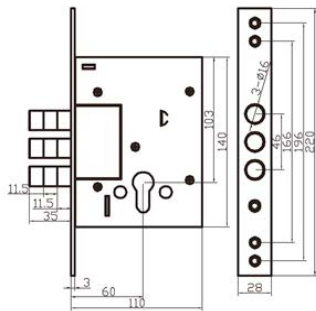

Backset: 60 mm  
 Dead Bolt: Triple Db16 mm Iron  
 Knob: Zinc Alloy

■ **262KB**

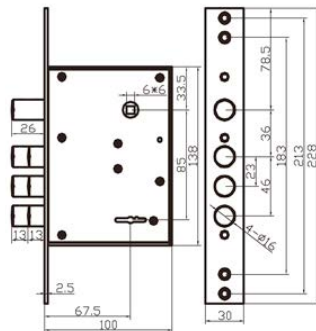

Backset: 67.5 mm  
 Center Distance: 85 mm  
 Latch Bolt: Single Db16 mm Iron  
 Dead Bolt: Triple Db16 mm Iron  
 Knob: Iron  
 Lever Handle Spindle: 6\*6 mm Square  
 Flat Tumbler: Iron  
 Key: Copper/ Nickel Plating

■ **262KS**

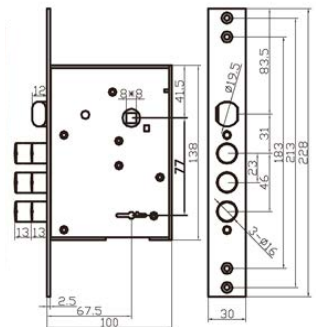

Backset: 67.5 mm  
 Center Distance: 77 mm  
 Latch Bolt: Single Db19.5 mm Iron  
 Dead Bolt: Triple Db16 mm Iron  
 Knob: Iron  
 Lever Handle Spindle: 8\*8 mm Square  
 Flat Tumbler: Iron  
 Key: Copper/ Nickel Plating



■ **262RL-1**

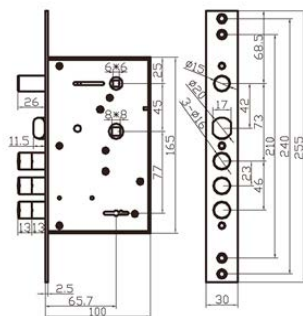

Backset: 67.5 mm  
 Center Distance  
 Lever Handle to Thumb Turn: 45 mm  
 Lever Handle to Keyhole: 77 mm  
 Latch Bolt: Single Db20 mm Iron  
 Dead Bolt: Triple Db16 mm Iron  
 Security Bolt: Single Db15 mm Iron  
 Knob: Powder Metallurgy Iron  
 Lever Handle Spindle: 8\*8 mm Square  
 Security Handle Spindle: 6\*6 mm Square  
 Flat Tumbler: Iron  
 Key: Copper/ Nickel Plating

■ **262RL**

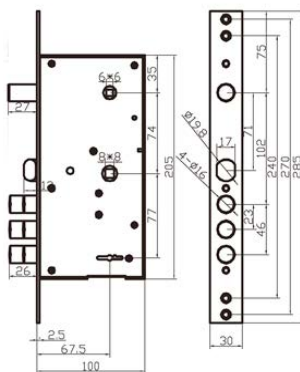

Backset: 67.5 mm  
 Center Distance  
 Lever Handle to Thumb Turn: 74 mm  
 Lever Handle to Keyhole: 77 mm  
 Latch Bolt: Single Db19.8 mm Iron  
 Dead Bolt: Triple Db16 mm Iron  
 Security Bolt: Single Db16 mm Iron  
 Knob: Powder Metallurgy Iron  
 Lever Handle Spindle: 8\*8 mm Square  
 Security Handle Spindle: 6\*6 mm Square  
 Flat Tumbler: Iron  
 Key: Copper/ Nickel Plating

■ **262RL-BC**

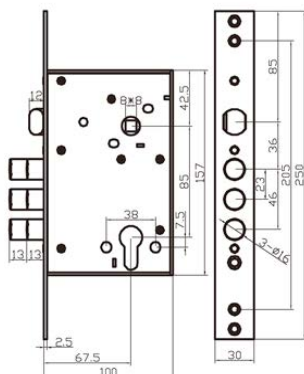

Backset: 67.5 mm  
 Center Distance: 85 mm  
 Latch Bolt: Single Db20 mm Iron  
 Dead Bolt: Triple Db16 mm Iron  
 Knob: Powder Metallurgy Iron  
 Lever Handle Spindle: 8\*8 mm Square

■ **262RL-C**

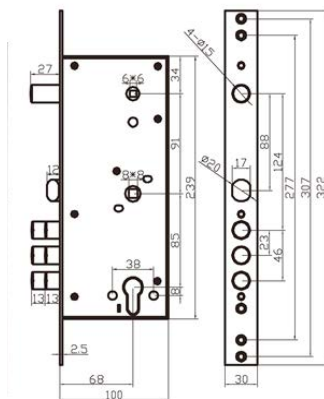

Backset: 68 mm  
 Center Distance  
 Lever Handle to Thumb Turn: 91 mm  
 Lever Handle to Keyhole: 85 mm  
 Latch Bolt: Single Db20 mm Iron  
 Dead Bolt: Triple Db16 mm Iron  
 Security Bolt: Single Db15 mm Iron  
 Knob: Powder Metallurgy Iron  
 Lever Handle Spindle: 8\*8 mm Square  
 Security Handle Spindle: 6\*6 mm Square

■ **352RL**

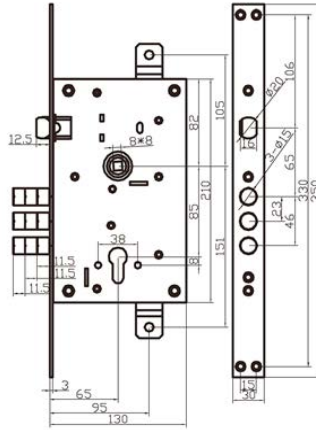

Backset: 65 mm  
 Center Distance: 85 mm  
 Latch Bolt: Single Db20 mm Iron  
 Dead Bolt: Triple Db15 mm Iron  
 Knob: Powder Metallurgy Iron  
 Lever Handle Spindle: 8\*8 mm Square

■ **362**

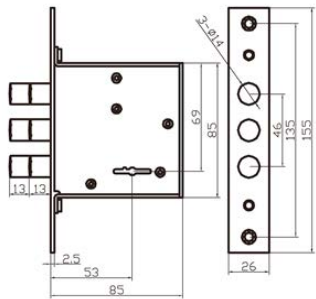

Backset: 53 mm  
 Dead Bolt: Triple Db14 mm Iron  
 Flat Tumbler: Iron  
 Key: Copper/ Nickel Plating

■ **362RL-KS**

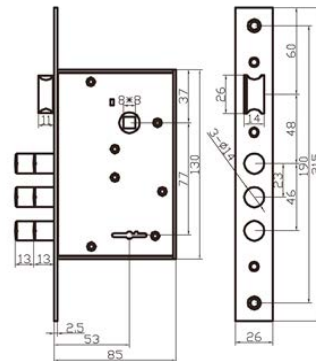

Backset: 53 mm  
 Center Distance: 77 mm  
 Latch Bolt: 26 mm Zinc Alloy  
 Dead Bolt: Triple Db14 mm Iron  
 Knob: Powder Metallurgy Iron  
 Lever Handle Spindle: 8\*8 mm Square  
 Flat Tumbler: Iron  
 Key: Copper/ Nickel Plating

■ **282**

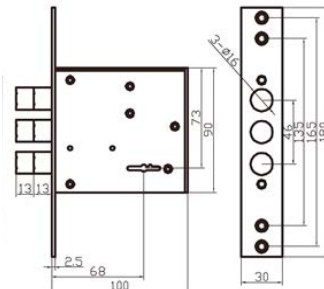

Backset: 68 mm  
 Dead Bolt: Triple Db16 mm Iron  
 Flat Tumbler: Iron  
 Key: Copper/ Nickel Plating

■ **SR500**

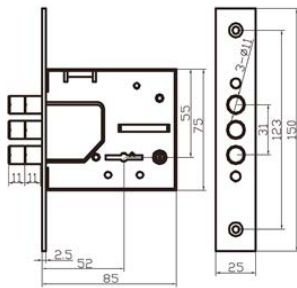

Backset: 52 mm  
 Dead Bolt: Triple Db11 mm Iron  
 Flat Tumbler: Iron  
 Key: Copper/ Nickel Plating

■ **GX1223**

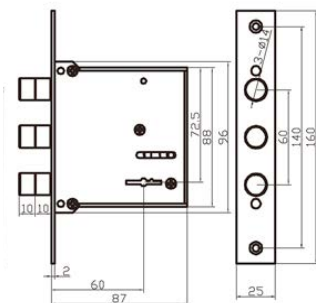

Backset: 60 mm  
 Dead Bolt: Triple Db14 mm Iron  
 Flat Tumbler: Iron  
 Key: Copper/ Nickel Plating

■ **256**

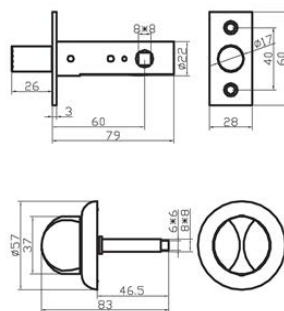

■ **CX8550C**

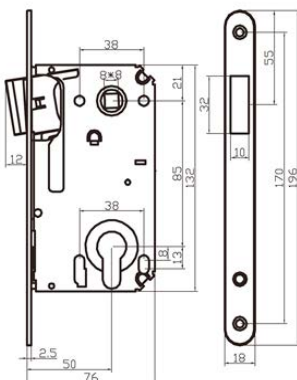

Backset: 50 mm  
 Center Distance: 85 mm  
 Latch Bolt: Magnet + Plastic  
 Knob: Metal Worked Sheet Iron  
 Lever Handle Spindle: 8\*8 mm Square

■ **CX9050B**

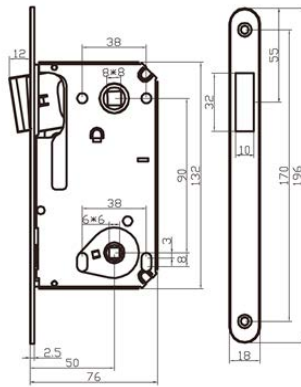

Backset: 50 mm  
 Center Distance: 90 mm  
 Latch Bolt: Magnet + Plastic  
 Knob: Metal Worked Sheet Iron  
 Lever Handle Spindle: 8\*8 mm Square  
 Thumb Turn Spindle: 6\*6 mm Square

■ **CX9050K**

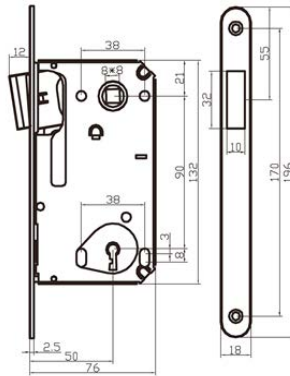

Backset: 50 mm  
 Center Distance: 90 mm  
 Latch Bolt: Magnet + Plastic  
 Knob: Metal Worked Sheet Iron  
 Lever Handle Spindle: 8\*8 mm Square  
 Key: Zinc Alloy/ Nickel Plating

■ **CX7050B**

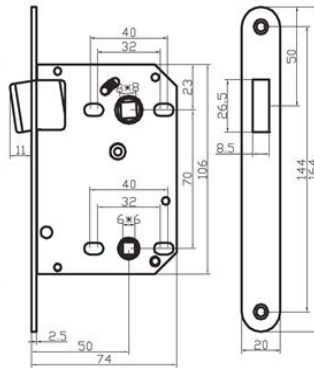

Backset: 50 mm  
 Center Distance: 70 mm  
 Latch Bolt: Magnet + Plastic  
 Knob: Metal Worked Sheet Iron  
 Lever Handle Spindle: 8\*8 mm Square  
 Thumb Turn Spindle: 6\*6 mm Square

■ **CX9050B-A**

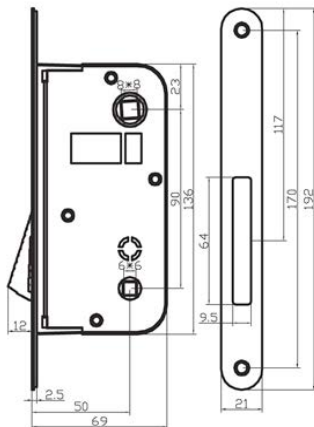

Backset: 50 mm  
 Center Distance: 90 mm  
 Latch Bolt: Magnet + Plastic  
 Lever Handle Knob: Zinc Alloy  
 Lever Handle Spindle: 8\*8 mm Square  
 Thumb Turn Knob: Plastic  
 Thumb Turn Spindle: 6\*6 mm Square

■ **CX8550C-A**

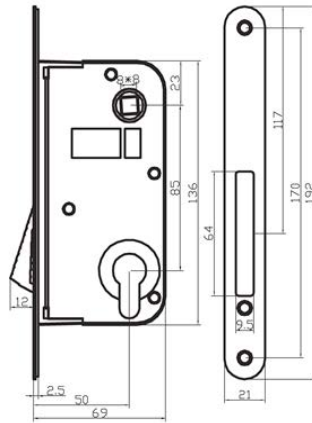

Backset: 50 mm  
 Center Distance: 85 mm  
 Latch Bolt: Magnet + Plastic  
 Knob: Zinc Alloy  
 Lever Handle Spindle: 8\*8 mm Square

■ **CX410C-S**

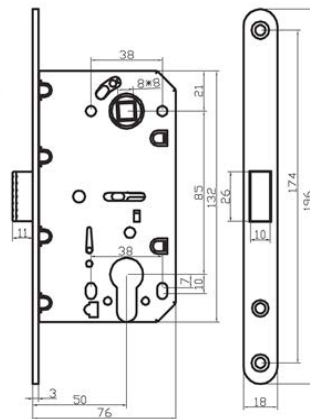

Backset: 50 mm  
 Center Distance: 85 mm  
 Latch Bolt: Magnet + Plastic  
 Knob: Zinc Alloy  
 Lever Handle Spindle: 8\*8 mm Square

■ **CX410B-S**

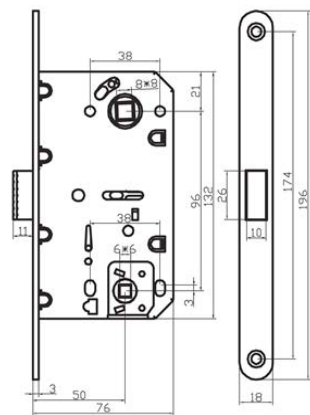

Backset: 50 mm  
 Center Distance: 96 mm  
 Latch Bolt: Magnet + Plastic  
 Lever Handle Knob: Zinc Alloy  
 Lever Handle Spindle: 8\*8 mm Square  
 Thumb Turn Kno: Plastic  
 Thumb Turn Spindle: 6\*6 mm Square

■ **CX410K-S**

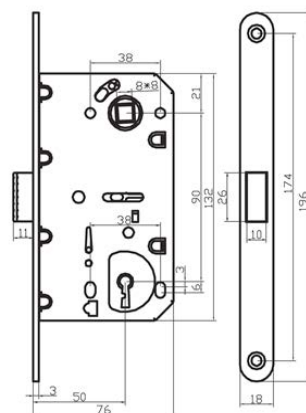

Backset: 50 mm  
 Center Distance: 96 mm  
 Latch Bolt: Magnet + Plastic  
 Knob: Zinc Alloy  
 Lever Handle Spindle: 8\*8 mm Square  
 Thumb Turn Spindle: 6\*6 mm Square  
 Key: Zinc Alloy/ Nickel Plating



**■ CX-03A**

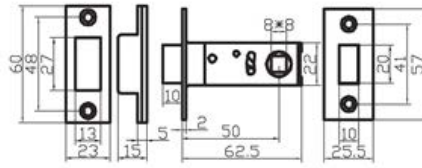

Backset: 50 mm

Latch Bolt: Magnet + Plastic

Knob: Zinc Alloy

Lever Handle Spindle: 8\*8 mm Square

**■ CX-03B**

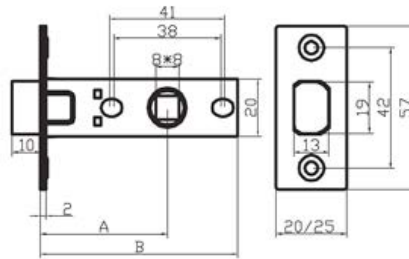

Backset: 45/50 mm

Latch Bolt: Zinc Alloy

Knob: Zinc Alloy

Lever Handle Spindle: 8\*8 mm Square

A	45	50
B	70	75

**■ CX-03S**

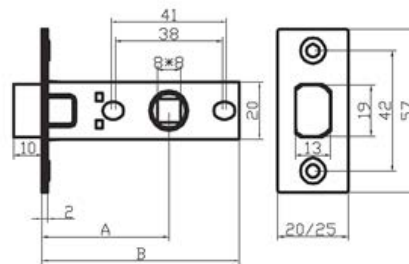

Backset: 45/50 mm

Latch Bolt: Plastic

Knob: Zinc Alloy

Lever Handle Spindle: 8\*8 mm Square

A	45	50
B	70	75

**■ C-03A**

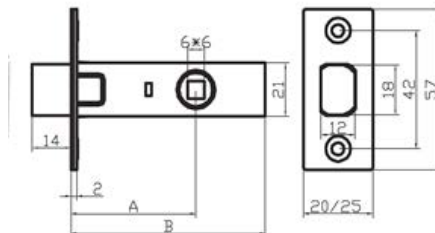

Backset: 45/50 mm

Dead Bolt: Zinc Alloy

Knob: Zinc Alloy

Lever Handle Spindle: 6\*6 mm Square

A	45	50
B	66	71

■ **C-03C**

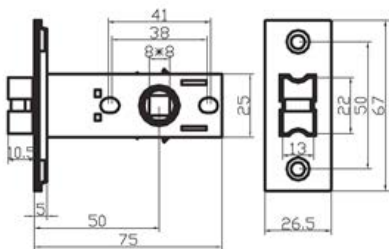

Backset: 45/50 mm  
 Dead Bolt: Zinc Alloy  
 Knob: Zinc Alloy  
 Lever Handle Spindle: 8\*8 mm Square

■ **SD410C**

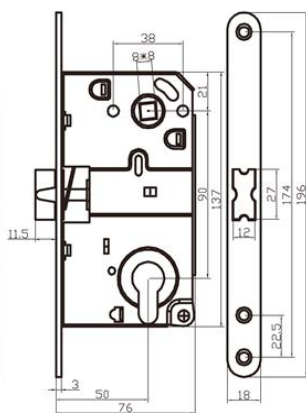

Backset: 50 mm  
 Center Distance: 90 mm  
 Latch Bolt: 27 mm Zinc Alloy  
 Knob: Zinc Alloy  
 Lever Handle Spindle: 8\*8 mm Square

■ **SD410B**

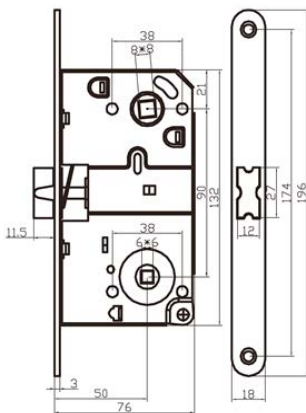

Backset: 50 mm  
 Center Distance: 90 mm  
 Latch Bolt: 27 mm Zinc Alloy  
 Knob: Zinc Alloy  
 Lever Handle Spindle: 8\*8 mm Square  
 Thumb Turn Spindle: 6\*6 mm Square

■ **SD410K**

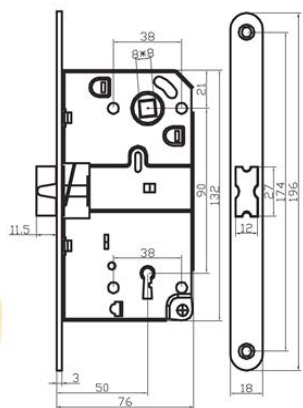

Backset: 50 mm  
 Center Distance: 90 mm  
 Latch Bolt: 27 mm Zinc Alloy  
 Knob: Zinc Alloy  
 Lever Handle Spindle: 8\*8 mm Square  
 Key: Zinc Alloy/ Nickel Plating

■ **SD410C-S**

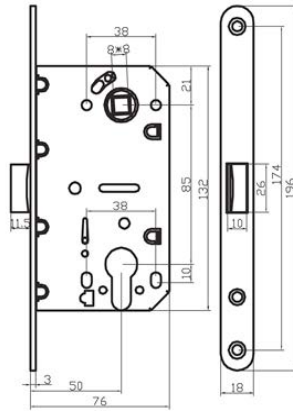

Backset: 50 mm  
 Center Distance: 85 mm  
 Latch Bolt: 26 mm Plastic  
 Knob: Zinc Alloy  
 Lever Handle Spindle: 8\*8 mm Square

■ **SD410B-S**

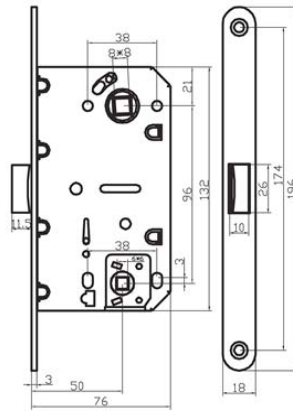

Backset: 50 mm  
 Center Distance: 96 mm  
 Latch Bolt: 26 mm Plastic  
 Knob: Zinc Alloy  
 Lever Handle Spindle: 8\*8 mm Square  
 Thumb Turn Spindle: 6\*6 mm Square

■ **SD410K-S**

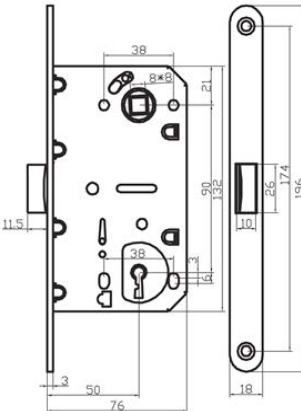

Backset: 50 mm  
 Center Distance: 90 mm  
 Latch Bolt: 26 mm Plastic  
 Knob: Zinc Alloy  
 Lever Handle Spindle: 8\*8 mm Square  
 Key: Zinc Alloy/ Nickel Plating

■ **185-1**

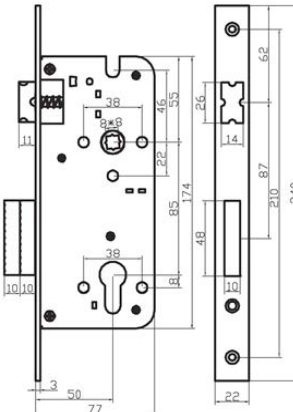

Backset: 50 mm  
 Center Distance: 85 mm  
 Latch Bolt: 26 mm Copper  
 Dead Bolt: 48 mm Copper  
 Knob: Zinc Alloy  
 Lever Handle Spindle: 8\*8 mm Square

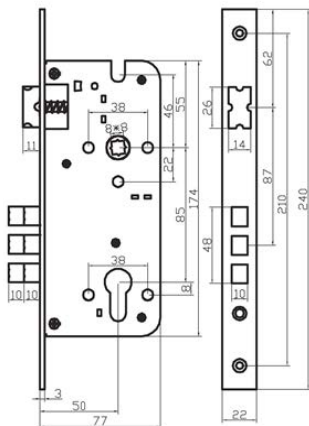

Backset: 50 mm  
 Center Distance: 85 mm  
 Latch Bolt: 26 mm Copper  
 Dead Bolt: Triple 10 mm Square  
 Copper  
 Knob: Zinc Alloy  
 Lever Handle Spindle: 8\*8 mm Square

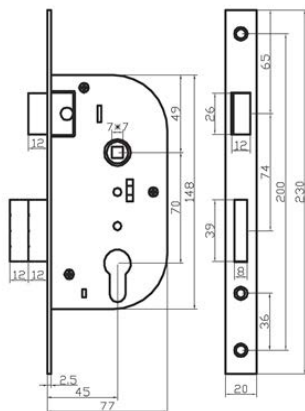

Backset: 45 mm  
 Center Distance: 70 mm  
 Latch Bolt: 26 mm Copper  
 Dead Bolt: 39 mm Copper  
 Knob: Zinc Alloy  
 Lever Handle Spindle: 7\*7 mm Square

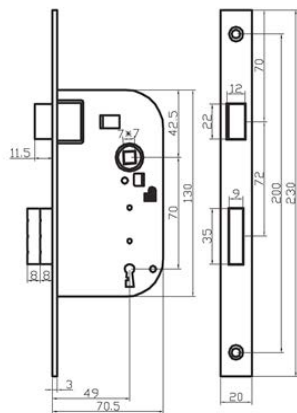

Backset: 49 mm  
 Center Distance: 70 mm  
 Latch Bolt: 22 mm Copper  
 Dead Bolt: 35 mm Copper  
 Knob: Zinc Alloy  
 Lever Handle Spindle: 7\*7 mm Square  
 Key: Zinc Alloy/ Nickel Plating

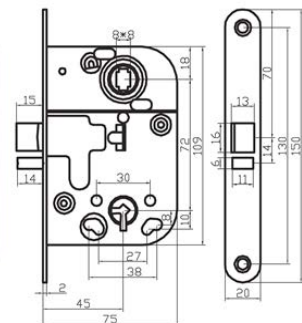

Backset: 45 mm  
 Center Distance: 72 mm  
 Latch Bolt: 16 mm Zinc Alloy  
 Dead Bolt: 6 mm Aluminum  
 Knob: Iron  
 Lever Handle Spindle: 8\*8 mm

■ **2018**

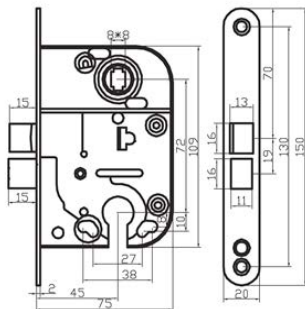

Backset: 45 mm  
 Center Distance: 72 mm  
 Latch Bolt: 16 mm Zinc Alloy  
 Dead Bolt: 16 mm Aluminum  
 Knob: Iron  
 Lever Handle Spindle: 8\*8 mm

■ **2019**

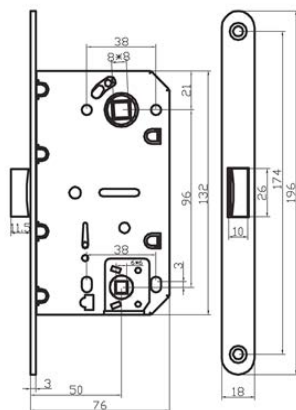

Backset: 45 mm  
 Center Distance: 72 mm  
 Latch Bolt: 22.5 mm Zinc Alloy  
 Knob: Iron  
 Lever Handle Spindle: 8\*8 mm

■ **2041**

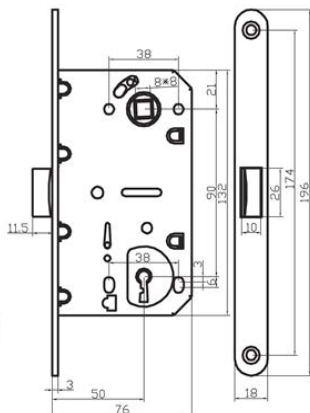

Backset: 45 mm  
 Center Distance: 72 mm  
 Latch Bolt: 22.5 mm Zinc Alloy  
 Knob: Iron  
 Lever Handle Spindle: 8\*8 mm  
 Key: Zinc Alloy/ Nickel Plating



■ **535K**

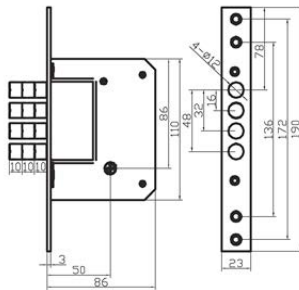

Backset: 50 mm  
Dead Bolt: Quadruple Db12 mm Iron

■ **536K**

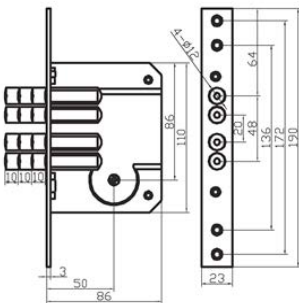

Backset: 50 mm  
Dead Bolt: Quadruple Db12 mm Iron

■ **537K**

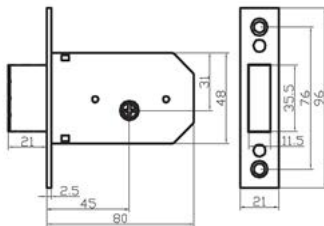

Backset: 45 mm  
Dead Bolt: 35.5 mm Zinc Alloy

■ **2800R-3M**

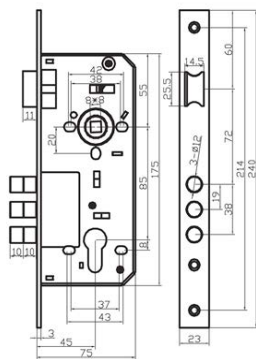

Backset: 45 mm  
Center Distance: 85 mm  
Latch Bolt: 25.5 mm Zinc Alloy  
Dead Bolt: Triple Db12 mm Iron  
Knob: Zinc Alloy  
Lever Handle Spindle: 8\*8 mm Square

■ **2800R**

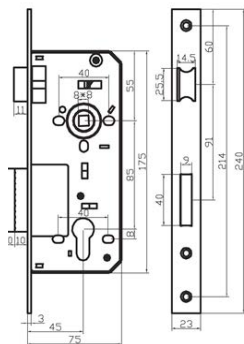

Backset: 45 mm  
Center Distance: 85 mm  
Latch Bolt: 25.5 mm Zinc Alloy  
Dead Bolt: 40 mm Iron  
Knob: Zinc Alloy  
Lever Handle Spindle: 8\*8 mm Square

■ **9010BB**

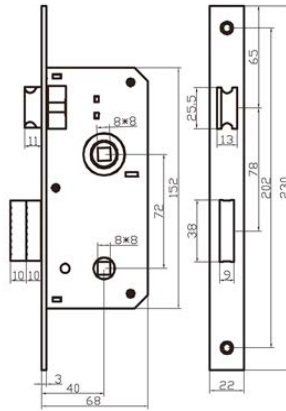

Backset: 40 mm  
 Center Distance: 72 mm  
 Latch Bolt: 25.5 mm Copper  
 Dead Bolt: 38 mm Iron  
 Knob: Zinc Alloy  
 Lever Handle Spindle: 8\*8 mm Square  
 Thumb Turn Spindle: 8\*8 mm Square

■ **9010BK**

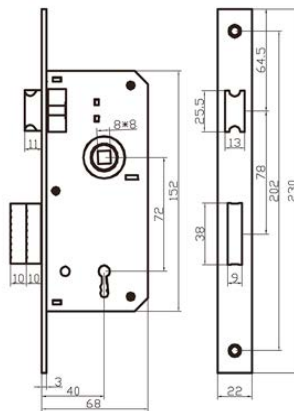

Backset: 40 mm  
 Center Distance: 72 mm  
 Latch Bolt: 25.5 mm Copper  
 Dead Bolt: 38 mm Iron  
 Knob: Zinc Alloy  
 Lever Handle Spindle: 8\*8 mm Square  
 Key: Zinc Alloy/ Nickel Plating

■ **510.40'45-R**

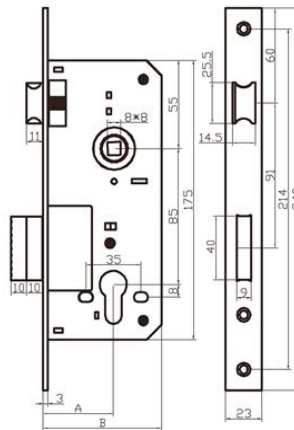

Backset: 40/45 mm  
 Center Distance: 85 mm  
 Latch Bolt: 25.5 mm Zinc Alloy  
 Dead Bolt: 40 mm Zinc Alloy  
 Knob: Zinc Alloy  
 Lever Handle Spindle: 8\*8 mm Square

■ **510.40-R3M**

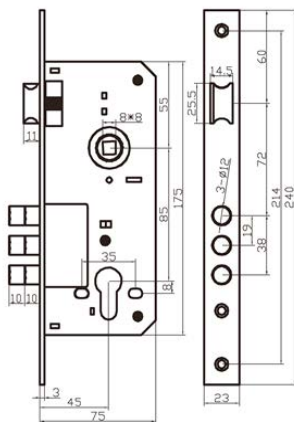

Backset: 45 mm  
 Center Distance: 85 mm  
 Latch Bolt: 25.5 mm Zinc Alloy  
 Dead Bolt: Triple Db12 mm Iron  
 Knob: Zinc Alloy  
 Lever Handle Spindle: 8\*8 mm Square

■ **521.40-R72**

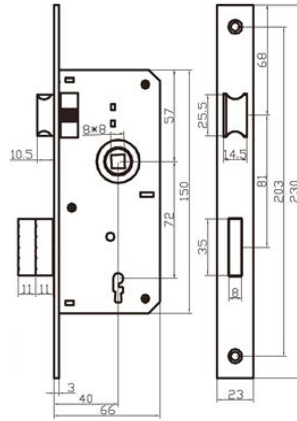

Backset: 40 mm  
 Center Distance: 72 mm  
 Latch Bolt: 25.5 mm Zinc Alloy  
 Dead Bolt: 35 mm Zinc Alloy  
 Knob: Zinc Alloy  
 Lever Handle Spindle: 8\*8 mm Square  
 Key: Zinc Alloy/ Nickel Plating

■ **521.40-72**

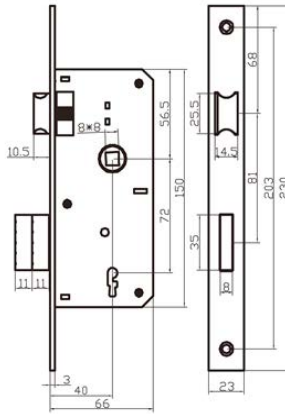

Backset: 40 mm  
 Center Distance: 72 mm  
 Latch Bolt: 25.5 mm Zinc Alloy  
 Dead Bolt: 35 mm Zinc Alloy  
 Knob: Zinc Alloy  
 Lever Handle Spindle: 8\*8 mm Square  
 Key: Zinc Alloy/ Nickel Plating

■ **521.40-R72**

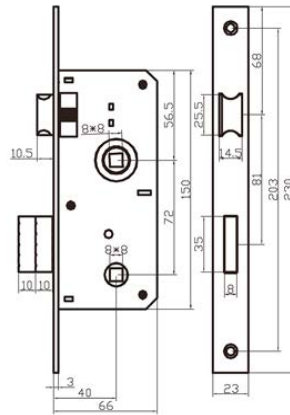

Backset: 40 mm  
 Center Distance: 72 mm  
 Latch Bolt: 25.5 mm Zinc Alloy  
 Dead Bolt: 35 mm Zinc Alloy  
 Knob: Zinc Alloy  
 Lever Handle Spindle: 8\*8 mm Square  
 Thumb Turn Spindle: 8\*8 mm Square

■ **522.40-72**

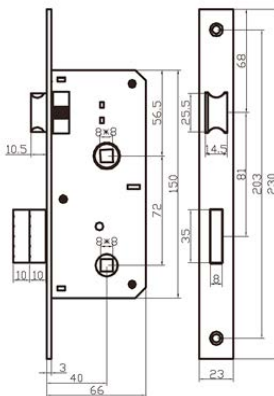

Backset: 40 mm  
 Center Distance: 72 mm  
 Latch Bolt: 25.5 mm Zinc Alloy  
 Dead Bolt: 35 mm Zinc Alloy  
 Knob: Zinc Alloy  
 Lever Handle Spindle: 8\*8 mm Square  
 Thumb Turn Spindle: 8\*8 mm Square



■ **152R-40**

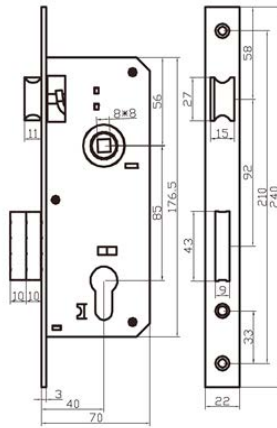

- Backset: 40 mm
- Center Distance: 85 mm
- Latch Bolt: 27 mm Zinc Alloy
- Dead Bolt: 43 mm Zinc Alloy
- Knob: Zinc Alloy
- Lever Handle Spindle: 8\*8 mm Square



■ **N511.21'25'30'35**

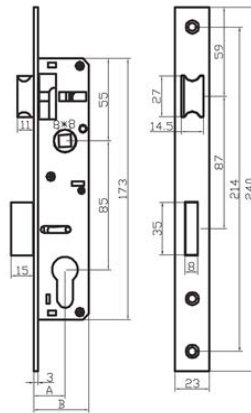

- Backset: 21/25/30/35 mm
- Center Distance: 85 mm
- Latch Bolt: 27 mm Zinc Alloy
- Dead Bolt: 35 mm Zinc Alloy
- Knob: Zinc Alloy
- Lever Handle Spindle: 8\*8 mm Square

■ **YSL9050B**

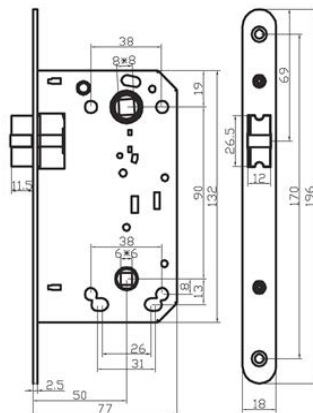

Backset: 50 mm  
 Center Distance: 90 mm  
 Latch Bolt: 26.5 mm Zinc Alloy & Plastic  
 Knob: Zinc Alloy  
 Lever Handle Spindle: 8\*8 mm Square  
 Thumb Turn Spindle: 6\*6 mm Square

■ **YSL9050K**

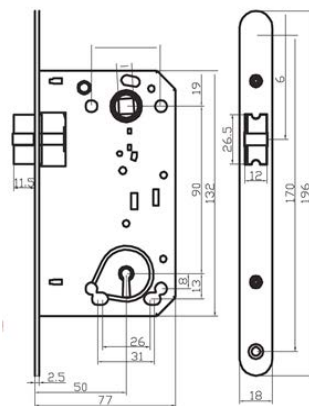

Backset: 50 mm  
 Center Distance: 85 mm  
 Latch Bolt: 26.5 mm Zinc Alloy & Plastic  
 Knob: Zinc Alloy  
 Lever Handle Spindle: 8\*8 mm Square  
 Key: Zinc Alloy/ Nickel Plating



■ **252RL**

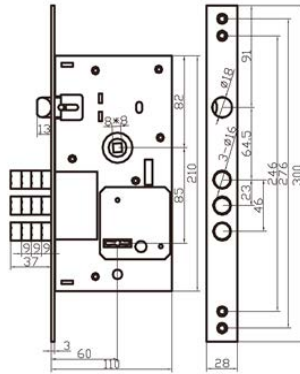

Backset: 60 mm  
 Center Distance: 85 mm  
 Latch Bolt: Single Db18 mm Iron  
 Dead Bolt: Triple Db16 mm Iron  
 Knob: Zinc Alloy  
 Lever Handle Spindle: 8\*8 mm Square  
 Flat Tumbler: Iron  
 Key: Copper/ Nickel Plating

■ **252RL-C**

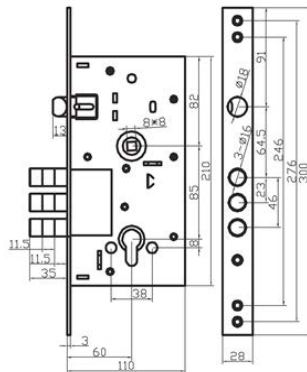

Backset: 60 mm  
 Center Distance: 85 mm  
 Latch Bolt: Single Db18 mm Iron  
 Dead Bolt: Triple Db16 mm Iron  
 Knob: Zinc Alloy  
 Lever Handle Spindle: 8\*8 mm Square

■ **C-501A**

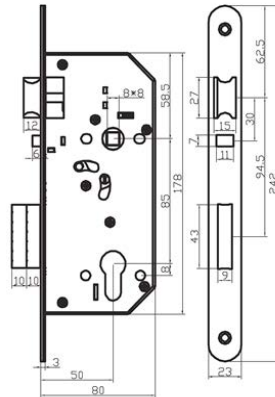

Backset: 50 mm  
 Center Distance: 85 mm  
 Latch Bolt: 27 mm Zinc Alloy  
 Dead Bolt: 43 mm Zinc Alloy  
 Knob: Zinc Alloy  
 Lever Handle Spindle: 8\*8 mm Square

■ **PL101**

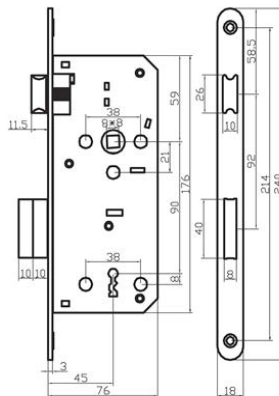

Backset: 45 mm  
 Center Distance: 90 mm  
 Latch Bolt: 26 mm Zinc Alloy  
 Dead Bolt: 40 mm Zinc Alloy  
 Knob: Zinc Alloy  
 Lever Handle Spindle: 8\*8 mm Square  
 Key: Zinc Alloy/ Nickel Plating

■ **1# 2#**

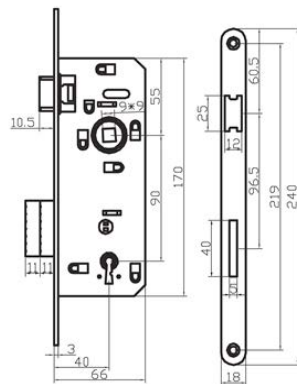

Backset: 40 mm  
 Center Distance: 90 mm  
 Latch Bolt: 25 mm Plastic  
 Dead Bolt: 40 mm Plastic  
 Knob: Nylon + Iron  
 Lever Handle Spindle: 9\*9 mm Square  
 Key: Zinc Alloy/ Nickel Plating

■ **3#**

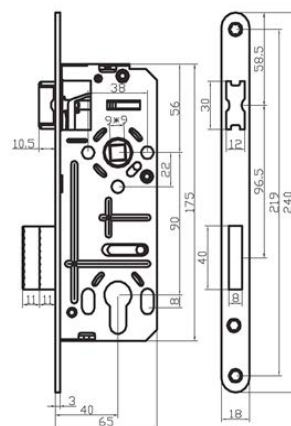

Backset: 40 mm  
 Center Distance: 90 mm  
 Latch Bolt: 30 mm Plastic  
 Dead Bolt: 40 mm Plastic  
 Knob: Nylon + Iron  
 Lever Handle Spindle: 9\*9 mm Square

■ **4#**

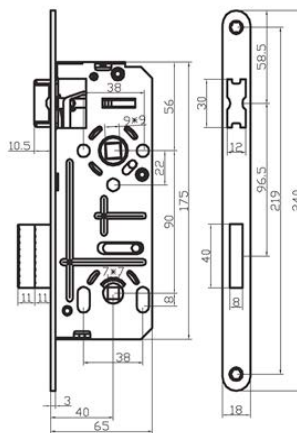

Backset: 40 mm  
 Center Distance: 90 mm  
 Latch Bolt: 30 mm Plastic  
 Dead Bolt: 40 mm Plastic  
 Knob: Nylon + Iron  
 Lever Handle Spindle: 9\*9 mm Square  
 Thumb Turn Spindle: 7\*7 mm Square

■ **5#**

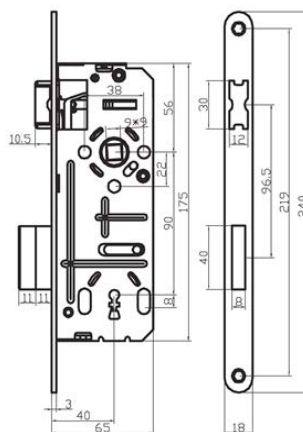

Backset: 40 mm  
 Center Distance: 90 mm  
 Latch Bolt: 30 mm Plastic  
 Dead Bolt: 40 mm Plastic  
 Knob: Nylon + Iron  
 Lever Handle Spindle: 9\*9 mm Square  
 Key: Zinc Alloy/ Nickel Plating

■ **6#**

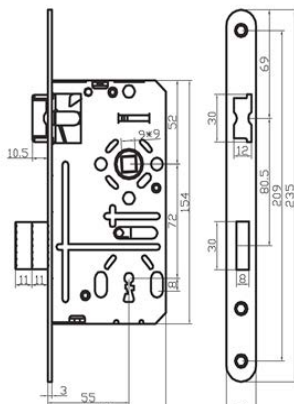

Backset: 55 mm  
 Center Distance: 72 mm  
 Latch Bolt: 30 mm Plastic  
 Dead Bolt: 30 mm Plastic  
 Knob: Nylon + Iron  
 Lever Handle Spindle: 9\*9 mm Square  
 Key: Zinc Alloy/ Nickel Plating

■ **7#**

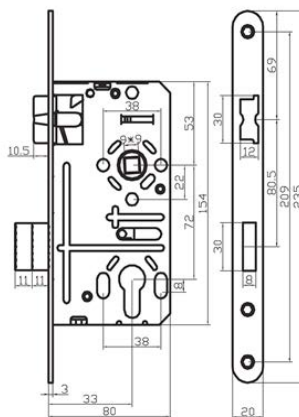

Backset: 33 mm  
 Center Distance: 72 mm  
 Latch Bolt: 30 mm Plastic  
 Dead Bolt: 30 mm Plastic  
 Knob: Nylon + Iron  
 Lever Handle Spindle: 9\*9 mm Square

■ **8#**

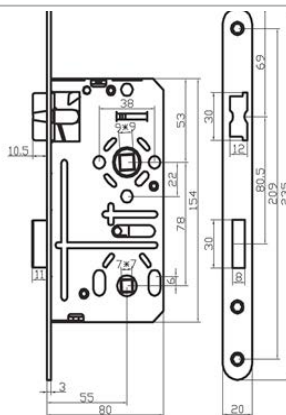

Backset: 55 mm  
 Center Distance: 78 mm  
 Latch Bolt: 30 mm Plastic  
 Dead Bolt: 30 mm Plastic  
 Knob: Nylon + Iron  
 Lever Handle Spindle: 9\*9 mm Square  
 Thumb Turn Spindle: 7\*7 mm Square

■ **9#**

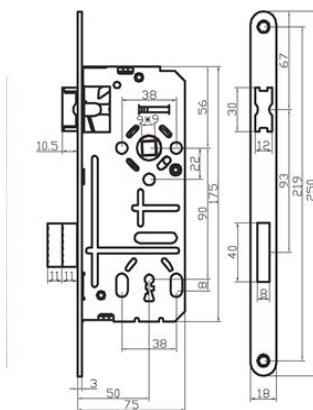

Backset: 50 mm  
 Center Distance: 90 mm  
 Latch Bolt: 30 mm Plastic  
 Dead Bolt: 40 mm Plastic  
 Knob: Nylon + Iron  
 Lever Handle Spindle: 9\*9 mm Square  
 Key: Zinc Alloy/ Nickel Plating

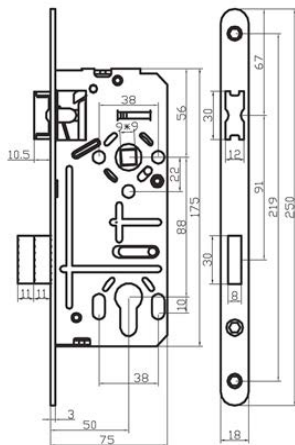

Backset: 50 mm  
 Center Distance: 88 mm  
 Latch Bolt: 30 mm Plastic  
 Dead Bolt: 30 mm Plastic  
 Knob: Nylon + Iron  
 Lever Handle Spindle: 9\*9 mm Square  
 Key: Zinc Alloy/ Nickel Plating

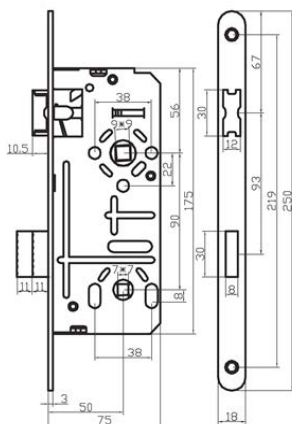

Backset: 50 mm  
 Center Distance: 90 mm  
 Latch Bolt: 30 mm Plastic  
 Dead Bolt: 30 mm Plastic  
 Knob: Nylon + Iron  
 Lever Handle Spindle: 9\*9 mm Square  
 Thumb Turn Spindle: 7\*7 mm Square

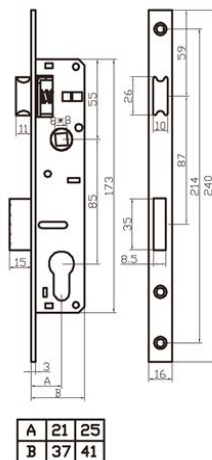

Backset: 21/25 mm  
 Center Distance: 85 mm  
 Latch Bolt: 26 mm Zinc Alloy  
 Dead Bolt: 35 mm Zinc Alloy  
 Knob: Zinc Alloy  
 Lever Handle Spindle: 8\*8 mm Square

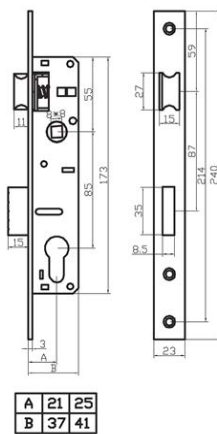

Backset: 40 mm  
 Center Distance: 90 mm  
 Latch Bolt: 30 mm Plastic  
 Dead Bolt: 40 mm Plastic  
 Knob: Nylon + Iron  
 Lever Handle Spindle: 9\*9 mm Square  
 Key: Zinc Alloy/ Nickel Plating



■ 153U-21'25

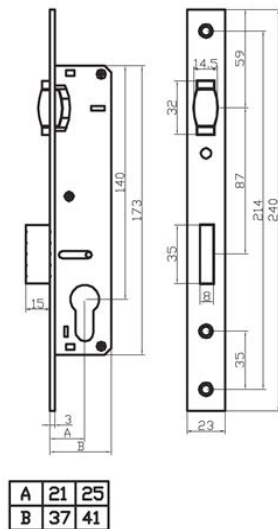

Backset: 21/25 mm  
 Lock Ball: 32 mm Copper  
 Dead Bolt: 35 mm Zinc Alloy  
 Knob: Zinc Alloy  
 Lever Handle Spindle: 8\*8 mm Square



■ 90135

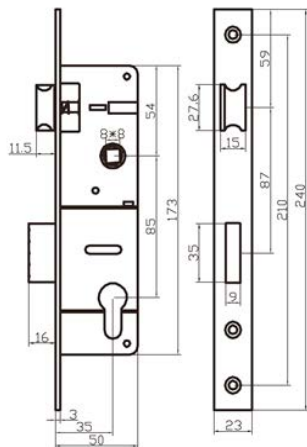

Backset: 35 mm  
 Center Distance: 85 mm  
 Latch Bolt: 27.6 mm Zinc Alloy  
 Dead Bolt: 35 mm Zinc Alloy  
 Knob: Zinc Alloy  
 Lever Handle Spindle: 8\*8 mm Square



■ 91135

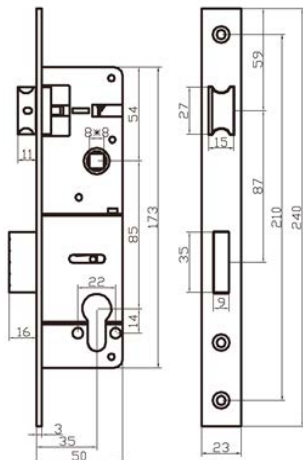

Backset: 35 mm  
 Center Distance: 85 mm  
 Latch Bolt: 27 mm Zinc Alloy  
 Dead Bolt: 35 mm Zinc Alloy  
 Knob: Zinc Alloy  
 Lever Handle Spindle: 8\*8 mm Square



■ **5090B**

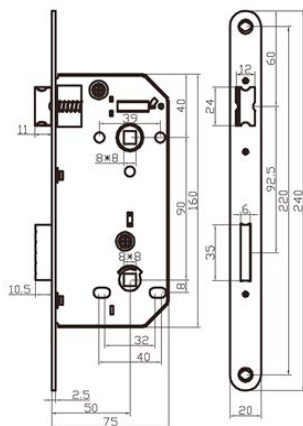

- Backset: 50 mm
- Center Distance: 90 mm
- Latch Bolt: 24 mm Zinc Alloy
- Dead Bolt: 35 mm Zinc Alloy
- Knob: Zinc Alloy
- Lever Handle Spindle: 8\*8 mm Square
- Thumb Turn Spindle: 8\*8 mm Square

■ **5090C**

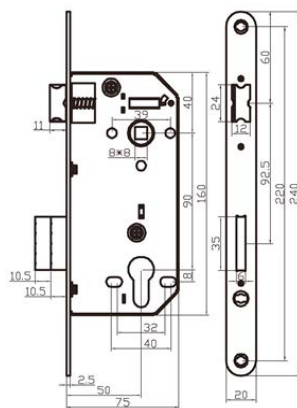

- Backset: 50 mm
- Center Distance: 90 mm
- Latch Bolt: 24 mm Zinc Alloy
- Dead Bolt: 35 mm Zinc Alloy
- Knob: Zinc Alloy
- Lever Handle Spindle: 8\*8 mm Square

■ **5090K**

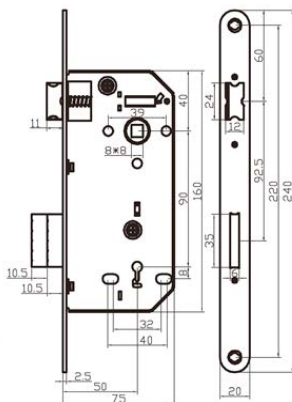

- Backset: 50 mm
- Center Distance: 90 mm
- Latch Bolt: 24 mm Zinc Alloy
- Dead Bolt: 35 mm Zinc Alloy
- Knob: Zinc Alloy
- Lever Handle Spindle: 8\*8 mm Square
- Key: Zinc Alloy/ Nickel Plating



■ **Z035R-2-K1**

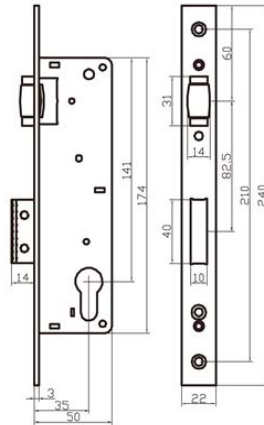

Backset: 35 mm  
 Lock Ball: 31 mm Copper  
 Dead Bolt: 40 mm Copper



■ **Z9235R-2-K1**

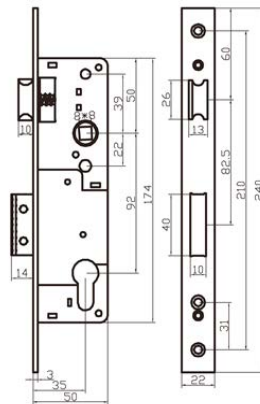

Backset: 35 mm  
 Center Distance: 92 mm  
 Latch Bolt: 26 mm Copper  
 Dead Bolt: 40 mm Copper  
 Knob: Zinc Alloy  
 Lever Handle Spindle: 8\*8 mm Square



■ **Z035B-2-K1**

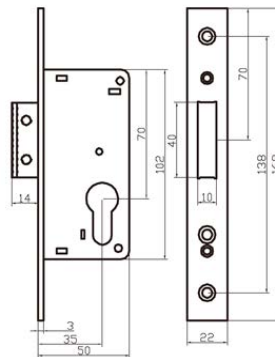

Backset: 35 mm  
 Dead Bolt: 40 mm Copper

■ **JH1001K**

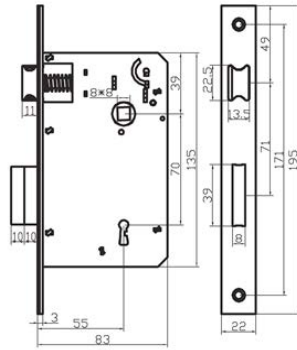

Backset: 55 mm  
 Center Distance: 70 mm  
 Latch Bolt: 22.5 mm Zinc Alloy  
 Dead Bolt: 39 mm Zinc Alloy  
 Knob: Zinc Alloy  
 Lever Handle Spindle: 8\*8 mm Square  
 Key: Zinc Alloy/ Nickel Plating

■ **JH1001C**

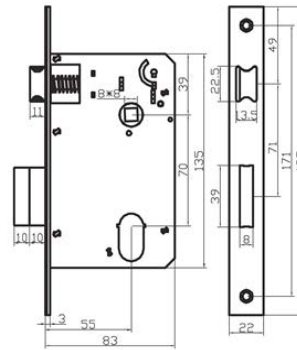

Backset: 55 mm  
 Center Distance: 70 mm  
 Latch Bolt: 22.5 mm Zinc Alloy  
 Dead Bolt: 39 mm Zinc Alloy  
 Knob: Zinc Alloy  
 Lever Handle Spindle: 8\*8 mm Square

■ **JH1001B**

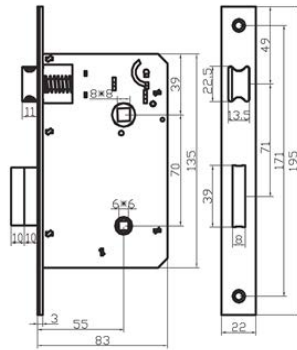

Backset: 55 mm  
 Center Distance: 70 mm  
 Latch Bolt: 22.5 mm Zinc Alloy  
 Dead Bolt: 39 mm Zinc Alloy  
 Knob: Zinc Alloy  
 Lever Handle Spindle: 8\*8 mm Square  
 Thumb Turn Spindle: 6\*6 mm Square

■ **JH1001U**

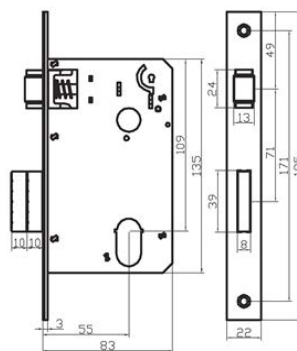

Backset: 55 mm  
 Lock Ball: 24 mm Zinc Alloy  
 Dead Bolt: 39 mm Zinc Alloy

■ **JH1002K**

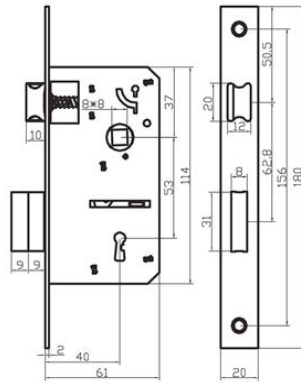

Backset: 40 mm  
 Center Distance: 53 mm  
 Latch Bolt: 20 mm Zinc Alloy  
 Dead Bolt: 31 mm Zinc Alloy  
 Knob: Zinc Alloy  
 Lever Handle Spindle: 8\*8 mm Square

■ **JH1002C**

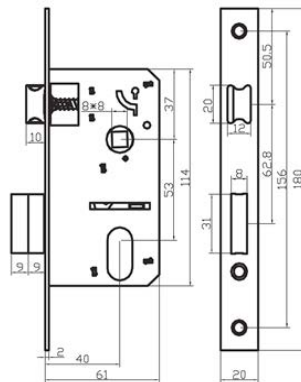

Backset: 40 mm  
 Center Distance: 53 mm  
 Latch Bolt: 20 mm Zinc Alloy  
 Dead Bolt: 31 mm Zinc Alloy  
 Knob: Zinc Alloy  
 Lever Handle Spindle: 8\*8 mm Square

■ **JH1002B**

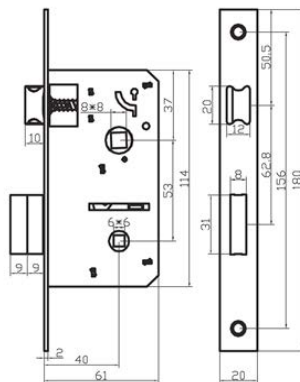

Backset: 40 mm  
 Center Distance: 53 mm  
 Latch Bolt: 20 mm Zinc Alloy  
 Dead Bolt: 31 mm Zinc Alloy  
 Knob: Zinc Alloy  
 Lever Handle Spindle: 8\*8 mm Square  
 Thumb Turn Spindle: 6\*6 mm Square

■ **JH2001**

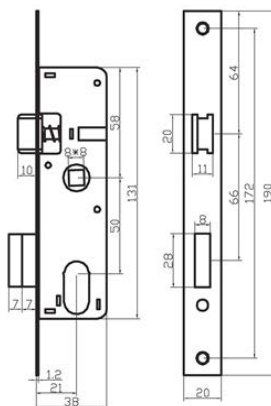

Backset: 21 mm  
 Center Distance: 50 mm  
 Latch Bolt: 20 mm Zinc Alloy  
 Dead Bolt: 28 mm Zinc Alloy  
 Knob: Zinc Alloy  
 Lever Handle Spindle: 8\*8 mm Square

■ **JH2002**

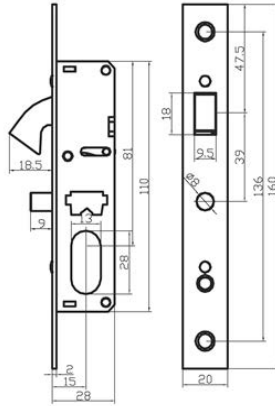

Backset: 15 mm  
Dead Bolt: Zinc Alloy

■ **JH1002C**



Backset: 50 mm  
Latch Bolt: 27 mm Zinc Alloy  
Knob: Zinc Alloy  
Lever Handle Spindle: 8\*8 mm Square  
Thumb Turn Spindle: 6\*6 mm Square

■ **9040C**

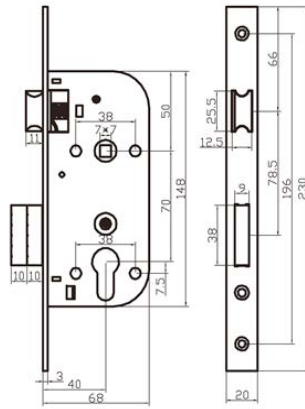

Backset: 40 mm  
 Center Distance: 70 mm  
 Latch Bolt: 25.5 mm Zinc Alloy  
 Dead Bolt: 38 mm Iron  
 Knob: Zinc Alloy  
 Lever Handle Spindle: 7\*7 mm Square

■ **9040B**

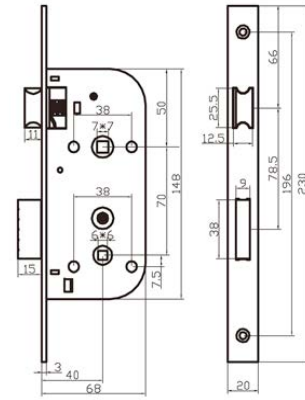

Backset: 40 mm  
 Center Distance: 70 mm  
 Latch Bolt: 25.5 mm Zinc Alloy  
 Dead Bolt: 38 mm Iron  
 Knob: Zinc Alloy  
 Lever Handle Spindle: 7\*7 mm Square  
 Thumb Turn Spindle: 6\*6 mm Square

■ **9040K**

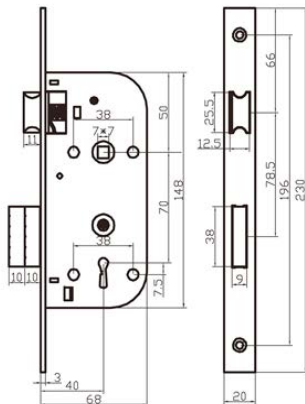

Backset: 40 mm  
 Center Distance: 70 mm  
 Latch Bolt: 25.5 mm Zinc Alloy  
 Dead Bolt: 38 mm Iron  
 Knob: Zinc Alloy  
 Lever Handle Spindle: 7\*7 mm Square  
 Key: Zinc Alloy/ Nickel Plating

■ **320BB**

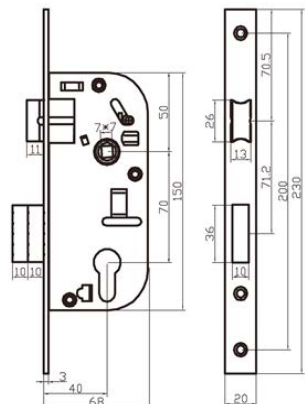

Backset: 40 mm  
 Center Distance: 70 mm  
 Latch Bolt: 25.5 mm Zinc Alloy  
 Dead Bolt: 38 mm Zinc Alloy  
 Knob: Zinc Alloy  
 Lever Handle Spindle: 7\*7 mm Square



■ **C001**

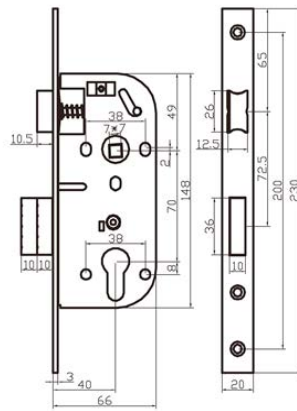

Backset: 40 mm  
 Center Distance: 70 mm  
 Latch Bolt: 26 mm Zinc Alloy  
 Dead Bolt: 36 mm Zinc Alloy  
 Knob: Zinc Alloy  
 Lever Handle Spindle: 7\*7 mm Square

■ **C002**

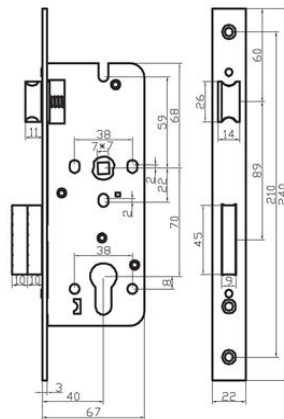

Backset: 40 mm  
 Center Distance: 70 mm  
 Latch Bolt: 26 mm Zinc Alloy  
 Dead Bolt: 45 mm Iron  
 Knob: Zinc Alloy  
 Lever Handle Spindle: 7\*7 mm Square

■ **C003**

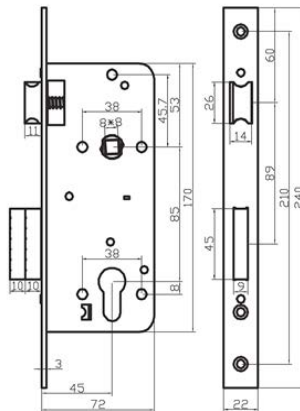

Backset: 45 mm  
 Center Distance: 85 mm  
 Latch Bolt: 26 mm Zinc Alloy  
 Dead Bolt: 45 mm Iron  
 Knob: Zinc Alloy  
 Lever Handle Spindle: 8\*8 mm Square

■ **C004**

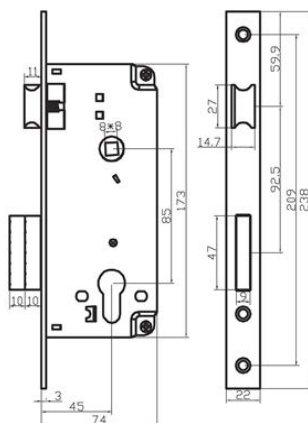

Backset: 45 mm  
 Center Distance: 85 mm  
 Latch Bolt: 27 mm Zinc Alloy  
 Dead Bolt: 47 mm Iron  
 Knob: Zinc Alloy  
 Lever Handle Spindle: 8\*8 mm Square

■ **700B**

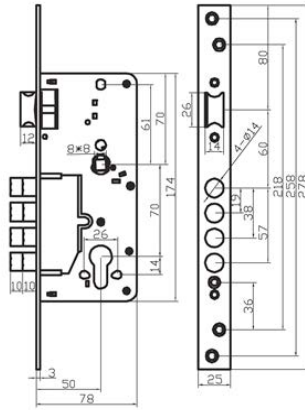

Backset: 50 mm  
 Center Distance: 70 mm  
 Latch Bolt: 26 mm Zinc Alloy  
 Dead Bolt: Quadruple Db14 mm Iron  
 Knob: Zinc Alloy  
 Lever Handle Spindle: 8\*8 mm Square

■ **706B**

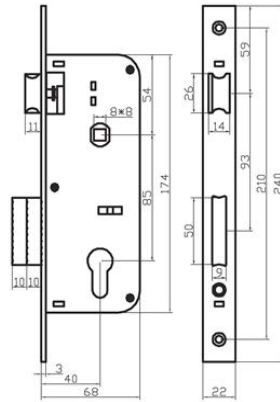

Backset: 40 mm  
 Center Distance: 85 mm  
 Latch Bolt: 26 mm Zinc Alloy  
 Dead Bolt: 50 mm Iron  
 Knob: Zinc Alloy  
 Lever Handle Spindle: 8\*8 mm Square

■ **PAH01**

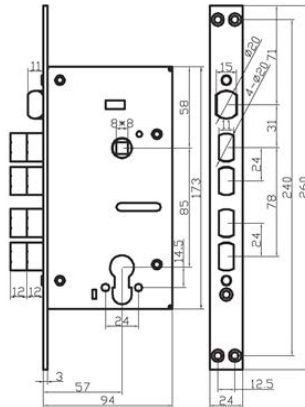

Backset: 57 mm  
 Center Distance: 85 mm  
 Latch Bolt: Single Db20 mm Iron  
 Dead Bolt: Quadruple Db20 mm Iron  
 Knob: Zinc Alloy  
 Lever Handle Spindle: 8\*8 mm Square

■ **240B-P-XT**

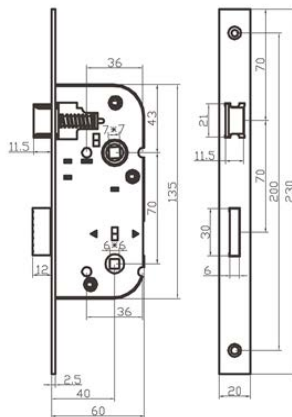

Backset: 40 mm  
 Center Distance: 70 mm  
 Latch Bolt: 21 mm Zinc Alloy  
 Dead Bolt: 30 mm Iron  
 Knob: Zinc Alloy  
 Lever Handle Spindle: 7\*7 mm Square  
 Thumb Turn Spindle: 6\*6 mm Square

■ **240K-P-XT**

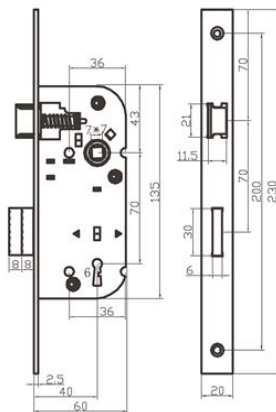

Backset: 40 mm  
 Center Distance: 70 mm  
 Latch Bolt: 21 mm Zinc Alloy  
 Dead Bolt: 30 mm Iron  
 Knob: Zinc Alloy  
 Lever Handle Spindle: 7\*7 mm Square  
 Key: Zinc Alloy/ Nickel Plating

■ **240C-P-ZN**

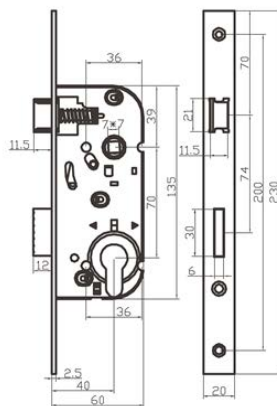

Backset: 40 mm  
 Center Distance: 70 mm  
 Latch Bolt: 21 mm Zinc Alloy  
 Dead Bolt: 30 mm Iron  
 Knob: Zinc Alloy  
 Lever Handle Spindle: 7\*7 mm Square

■ **310**

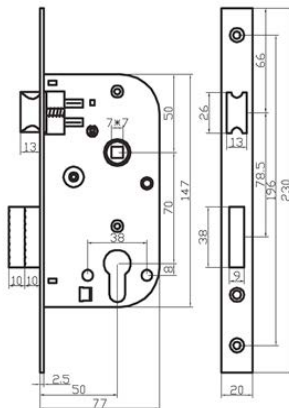

Backset: 50 mm  
 Center Distance: 70 mm  
 Latch Bolt: 26 mm Zinc Alloy  
 Dead Bolt: 38 mm Iron  
 Knob: Zinc Alloy  
 Lever Handle Spindle: 7\*7 mm Square

■ **8945**

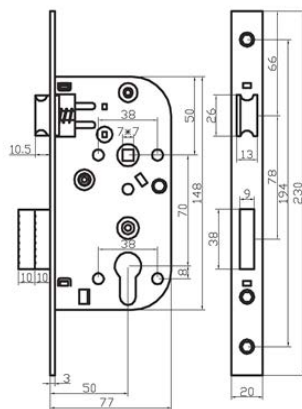

Backset: 50 mm  
 Center Distance: 70 mm  
 Latch Bolt: 26 mm Zinc Alloy  
 Dead Bolt: 38 mm Zinc Alloy  
 Knob: Zinc Alloy  
 Lever Handle Spindle: 7\*7 mm Square

■ **G8945**

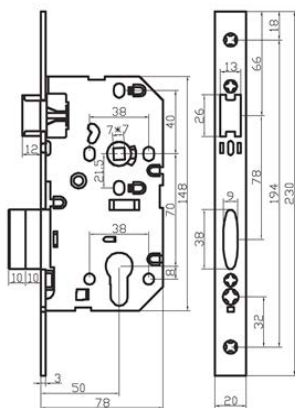

Backset: 50 mm  
 Center Distance: 70 mm  
 Latch Bolt: 26 mm Zinc Alloy  
 Dead Bolt: 38 mm Zinc Alloy  
 Knob: Zinc Alloy  
 Lever Handle Spindle: 7\*7 mm Square

■ **6458**

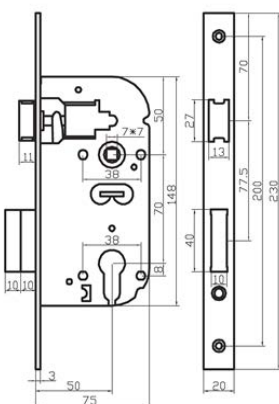

Backset: 50 mm  
 Center Distance: 70 mm  
 Latch Bolt: 27 mm Zinc Alloy  
 Dead Bolt: 40 mm Zinc Alloy  
 Knob: Zinc Alloy  
 Lever Handle Spindle: 7\*7 mm Square

■ **G6458**

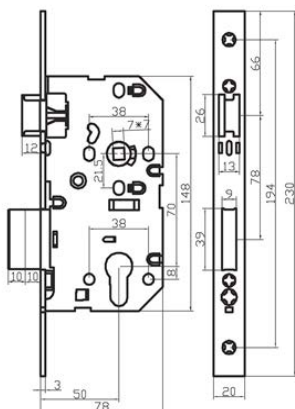

Backset: 50 mm  
 Center Distance: 70 mm  
 Latch Bolt: 26 mm Zinc Alloy  
 Dead Bolt: 39 mm Zinc Alloy  
 Knob: Zinc Alloy  
 Lever Handle Spindle: 7\*7 mm Square

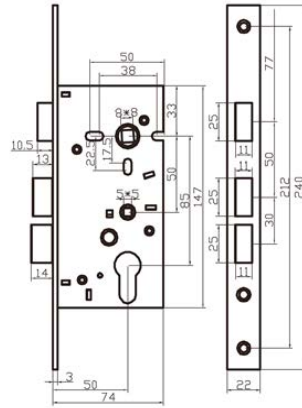
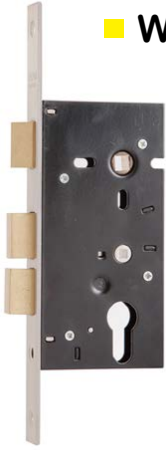
**LOCK BODY****Australia**■ **W85**

- Backset: 50 mm
- Center Distance
- Lever Handle to Thumb Turn: 50 mm
- Lever Handle to Keyhole: 85 mm
- Latch Bolt: 25 mm Copper
- Dead Bolt: Double 25 mm Copper
- Knob: Zinc Alloy
- Lever Handle Spindle: 8\*8 mm Square

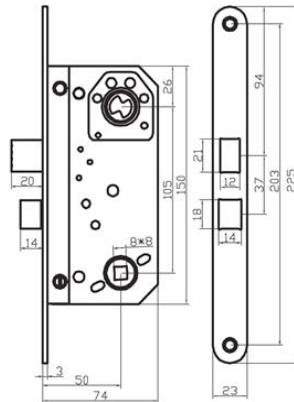
**LOCK BODY****Northern Europe**■ **4565**

- Backset: 55 mm
- Center Distance: 105 mm
- Latch Bolt: 27 mm Iron
- Dead Bolt: 30 mm Iron
- Knob: Iron
- Lever Handle Spindle: 8\*8 mm Square

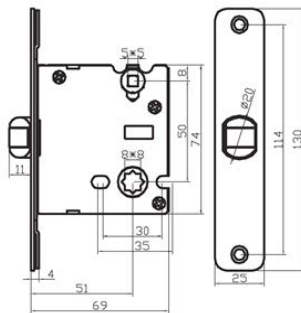
**LOCK BODY****Asian / Japan**■ **815**

- Backset: 51 mm
- Center Distance: 50 mm
- Latch Bolt: Db20 mm Iron & Plastic
- Knob: Zinc Alloy
- Lever Handle Spindle: 8\*8 mm
- Thumb Turn Spindle: 5\*5 mm Square

■ **2020-120'140**

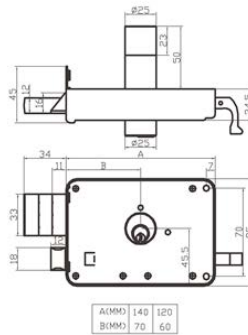

Backset: 60/70 mm  
 Latch Bolt: 18 mm Copper  
 Handle: Copper  
 Dead Bolt: 33 mm Iron  
 Cylinder: Copper

■ **3425-100'120'140**

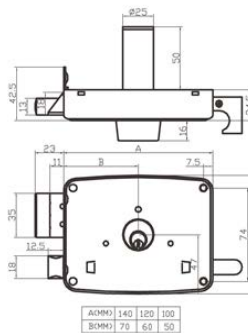

Backset: 50/60/70 mm  
 Latch Bolt: 18 mm Zinc Alloy  
 Handle: Zinc Alloy  
 Dead Bolt: 35 mm Zinc Alloy  
 Cylinder: Copper

■ **1494-100'120'140**

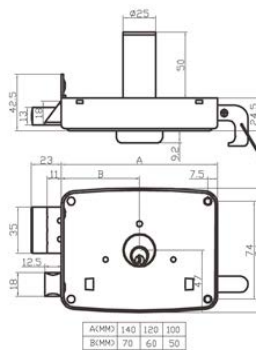

Backset: 50/60/70 mm  
 Latch Bolt: 18 mm Zinc Alloy  
 Handle: Zinc Alloy  
 Dead Bolt: 35 mm Zinc Alloy  
 Cylinder: Copper

■ **6083**

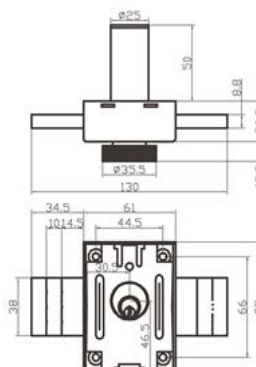

Backset: 30.5 mm  
 Dead Bolt: 38 mm Iron  
 Thumb Turn: Zinc Alloy



■ **X458**

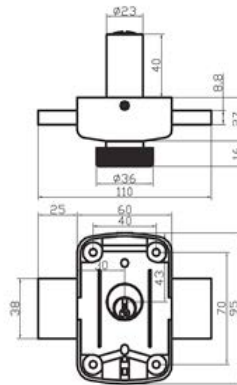

Backset: 30 mm  
 Dead Bolt: 38 mm Iron  
 Thumb Turn: Plastic

■ **0458**

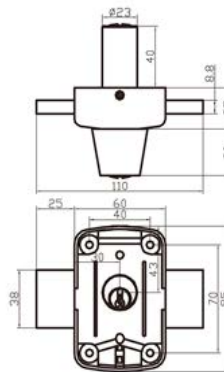

Backset: 30 mm  
 Dead Bolt: 38 mm Iron  
 Cylinder: Copper

■ **1120**

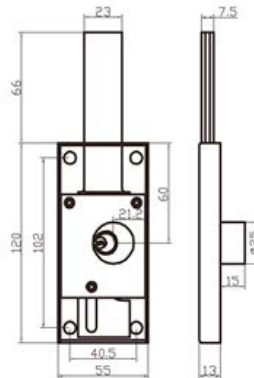

Backset: 60 mm  
 Dead Bolt: 23 mm Iron  
 Cylinder: Copper

■ **1121**

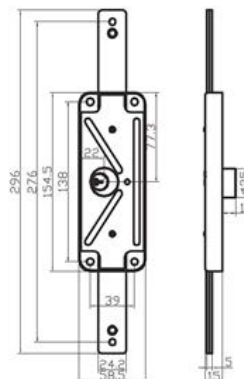

Backset: 77.3 mm  
 Dead Bolt: 24.2 mm Iron  
 Cylinder: Copper

■ **G720**

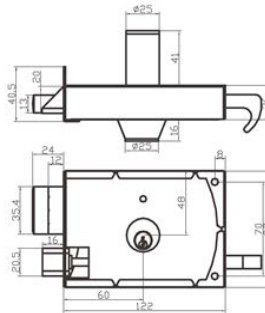

Backset: 60 mm  
 Latch Bolt: 20.5 mm Copper  
 Handle: Copper  
 Dead Bolt: 35.4 mm Iron  
 Cylinder: Copper

■ **4500**

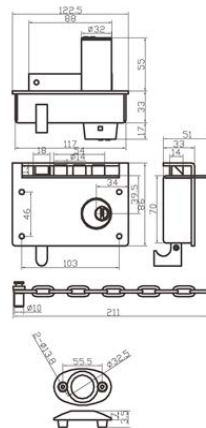

Backset: 34 mm  
 Latch Bolt: 18 mm Zinc Alloy  
 Handle: Zinc Alloy  
 Dead Bolt: Triple Db14 mm Iron  
 Cylinder: Copper

■ 1367

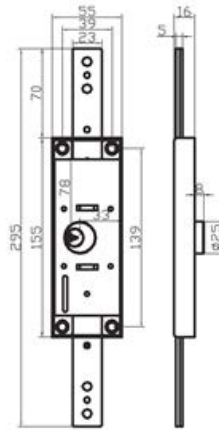

Backset: 78 mm  
 Dead Bolt: 23 mm Iron  
 Cylinder: Copper

■ 2930

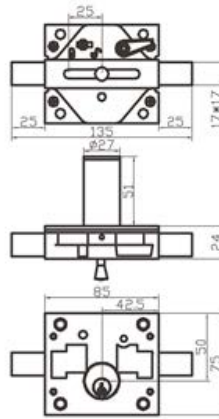

Dead Bolt: Iron  
 Handle: Iron

■ 50121.10-3M

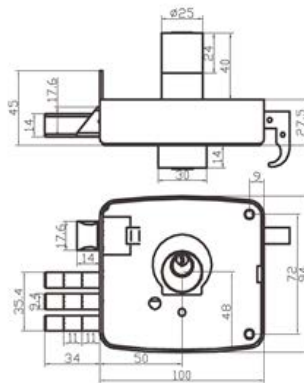

Backset: 50 mm  
 Latch Bolt: 17.6 mm Copper  
 Handle: Copper  
 Dead Bolt: Triple Db9.4 mm Iron  
 Cylinder: Copper

■ 50121.10

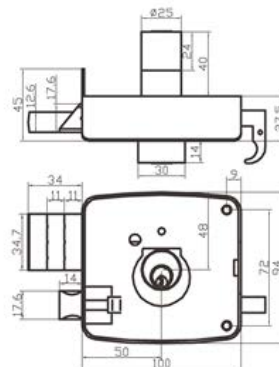

Backset: 50 mm  
 Latch Bolt: 17.6 mm Copper  
 Handle: Copper  
 Dead Bolt: 34.7 mm Copper  
 Cylinder: Copper

■ **630**

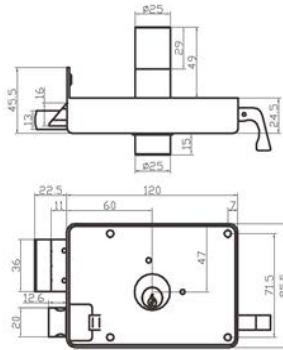

Backset: 60 mm  
 Latch Bolt: 20 mm Copper  
 Handle: Copper  
 Dead Bolt: 36 mm Copper  
 Cylinder: Copper

■ **630F**

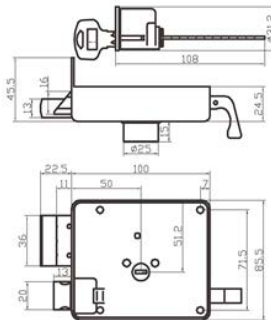

Backset: 50 mm  
 Latch Bolt: 20 mm Copper  
 Handle: Copper  
 Dead Bolt: 36 mm Copper  
 Cylinder: Copper

■ **540.12'14-3M**

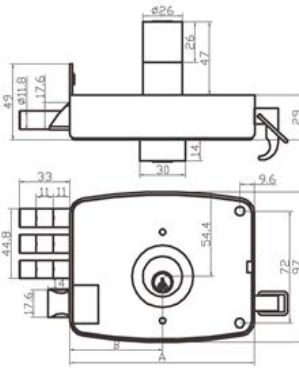

Backset: 60/70 mm  
 Latch Bolt: 17.6 mm Copper  
 Handle: Copper  
 Dead Bolt: Triple Db11.8 mm Iron  
 Cylinder: Copper

■ **540.10'12'14**

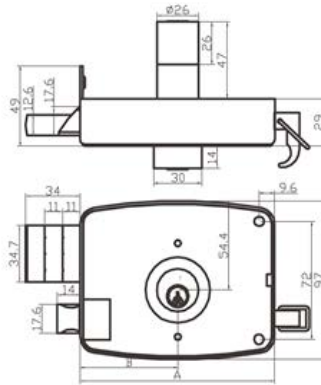

Backset: 50/60/70 mm  
 Latch Bolt: 17.6 mm Copper  
 Handle: Copper  
 Dead Bolt: 34.7 mm Copper  
 Cylinder: Copper

■ **540.14-AG**

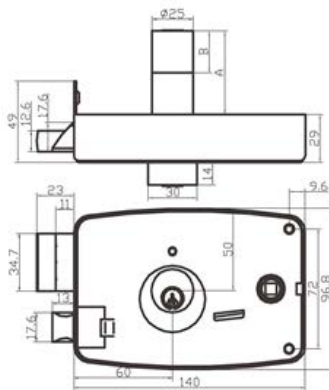

Backset: 60 mm  
 Latch Bolt: 17.6 mm Copper  
 Dead Bolt: 34.7 mm Copper  
 Knob: Copper  
 Cylinder: Copper

■ **S540.14-3M**

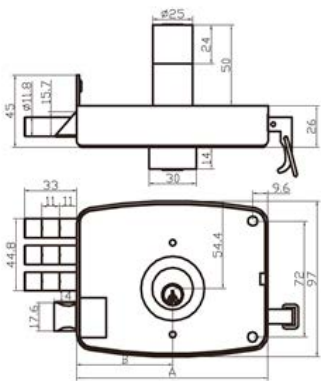

Backset: 60/70 mm  
 Latch Bolt: 17.6 mm Copper  
 Handle: Copper  
 Dead Bolt: Triple Db11.8 mm Iron  
 Cylinder: Copper

■ **1710**

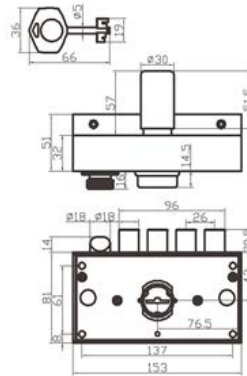

Backset: 76.5 mm  
 Latch Bolt: Single Db18 mm Iron  
 Dead Bolt: Quadruple Db18 mm Iron  
 Thumb Turn: Iron  
 Cylinder: Iron  
 Key: Copper

■ **1712**

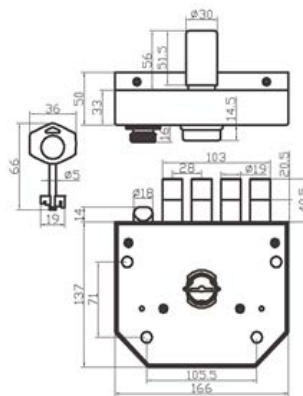

Latch Bolt: Single Db18 mm Iron  
 Dead Bolt: Quadruple Db19 mm Iron  
 Thumb Turn: Iron  
 Cylinder: Iron  
 Key: Copper



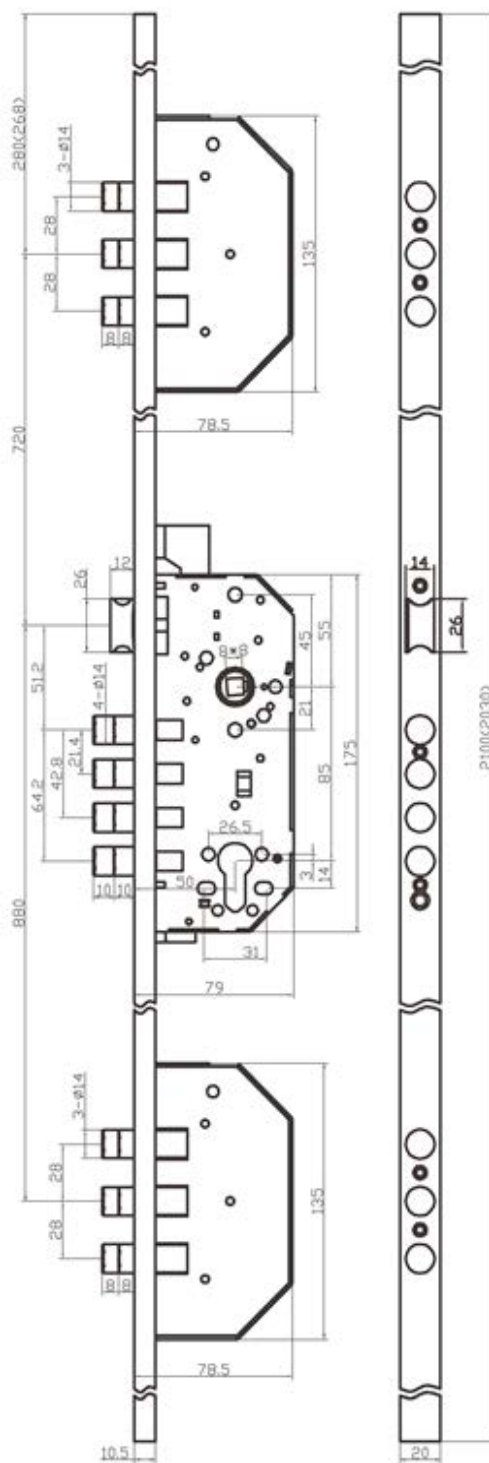

■ **3201B-TB**

- Backset: 50 mm
- Center Distance: 85 mm
- Latch Bolt: 26 mm Zinc Alloy
- Dead Bolt: Quadruple Db14 mm Iron
- Knob: Zinc Alloy
- Lever Handle Spindle: 8\*8 mm Square
- Block Lock Dead Bolt: Triple Db14 mm Iron

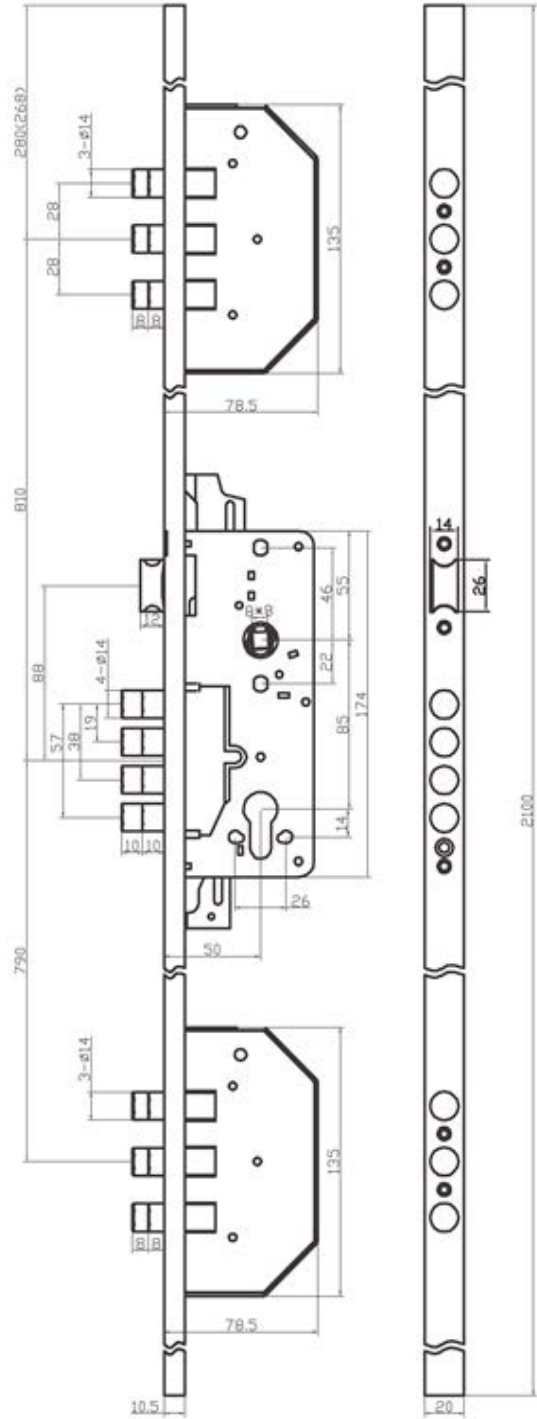

■ **700B-TB**

Backset: 50 mm  
 Center Distance: 85 mm  
 Latch Bolt: 26 mm Zinc Alloy  
 Dead Bolt: Quadruple Db14 mm Iron  
 Knob: Zinc Alloy  
 Lever Handle Spindle: 8\*8 mm Square  
 Block Lock Dead Bolt: Triple Db14 mm Iron

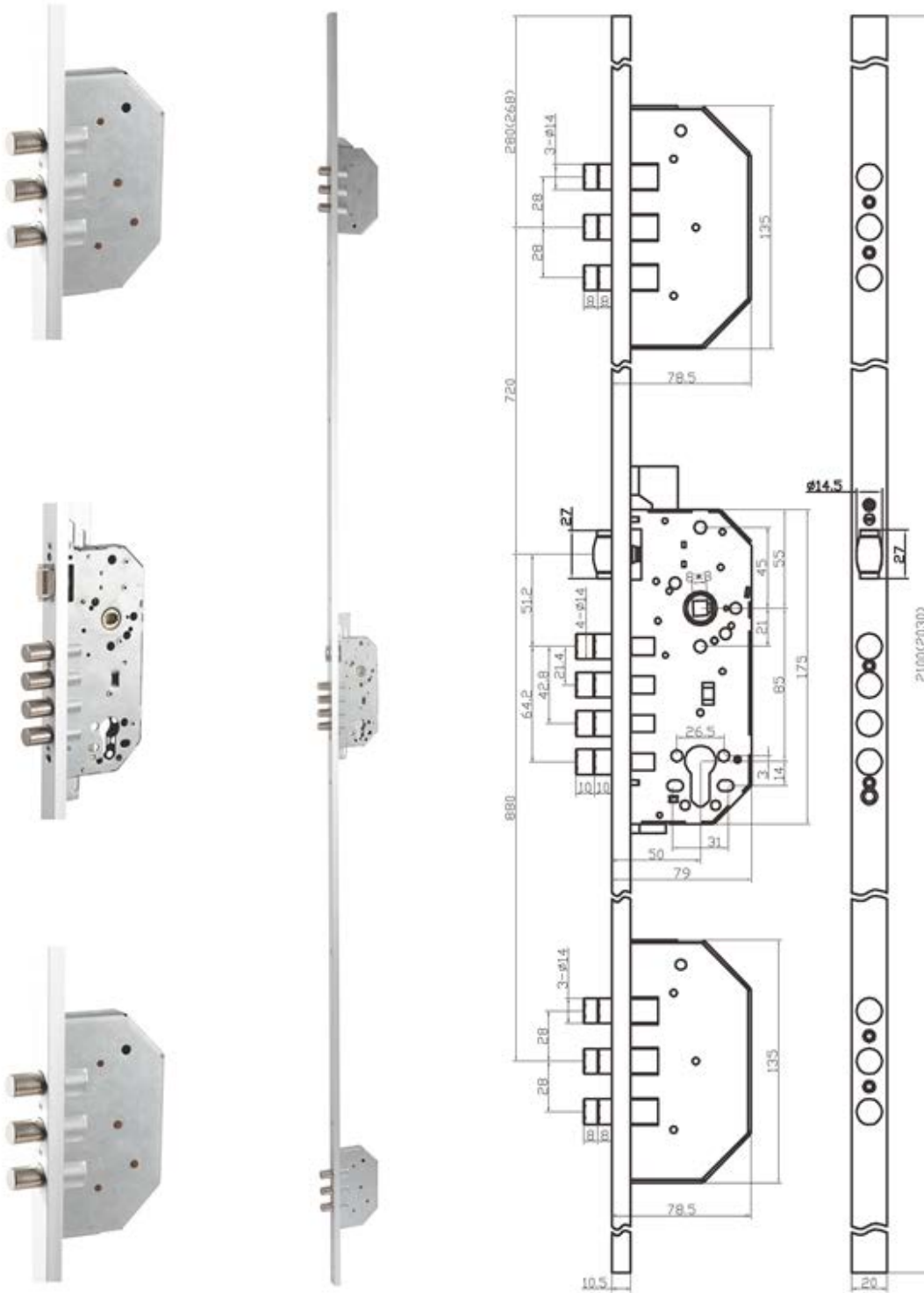

■ **3201B-TG ROLLER**

- Backset: 50 mm
- Center Distance: 85 mm
- Lock Ball: 27 mm Copper
- Dead Bolt: Quadruple Db14 mm Iron
- Knob: Zinc Alloy
- Lever Handle Spindle: 8\*8 mm Square
- Block Lock Dead Bolt: Triple Db14 mm Iron

**■ SH-01**

Material: Alumium  
Surface: Satin Nickel/  
Chrome Plated

**■ SH-02**

Material: Alumium  
Surface: Satin Nickel

**■ SH-03**

Material: Alumium  
Surface: Satin Nickel

**■ SH-04**

Material: Alumium  
Surface: Satin Nickel

■ **SH-05**



Material: Alumium  
Surface: Satin Nickel

■ **SH-06**



Material: Alumium  
Surface: Satin Nickel

■ **SH-07**



Material: Alumium  
Surface: Satin Nickel

■ **SH-08**



Material: Alumium  
Surface: Satin Nickel

■ **1919 ROUND**

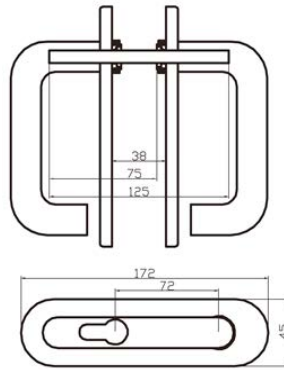

■ **1919 SQUARE**

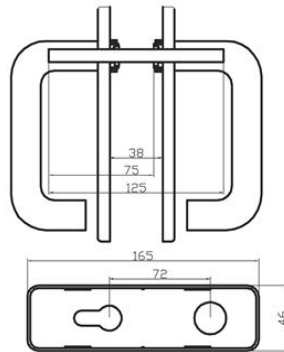

■ **1919-1**

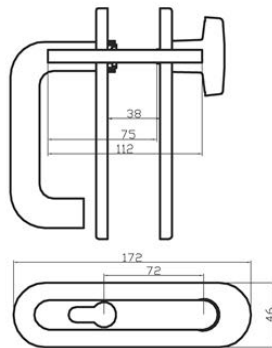



■ 19-006

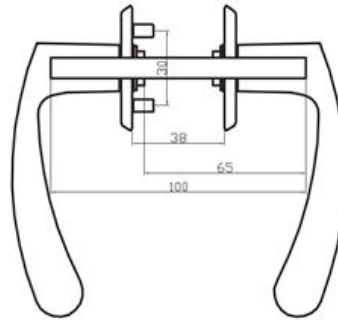

Handle: Aluminum  
Case: Iron

■ 16'006

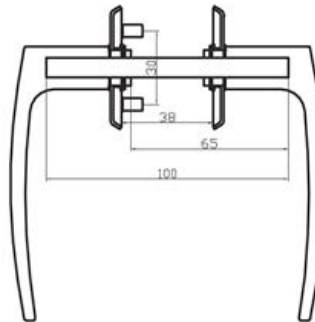

Handle: Aluminum  
Case: Iron

■ H032

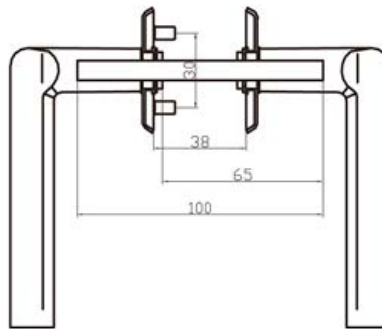

Handle: Zinc Alloy  
Case: Iron

■ H033

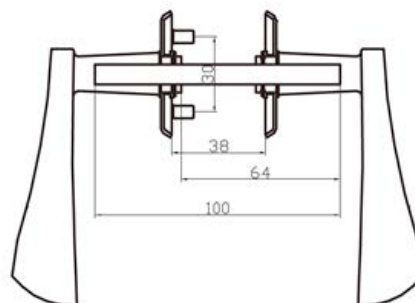

Handle: Zinc Alloy  
Case: Iron

■ **9114C'B'K**

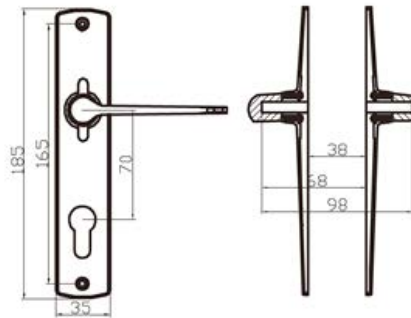

Handle: Aluminum  
Case: Iron

■ **4230**

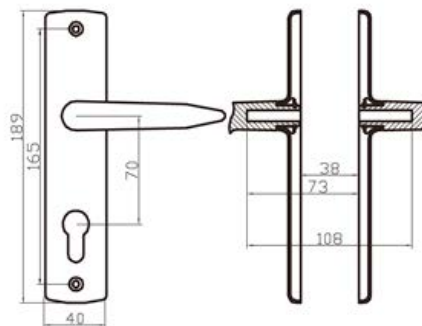

Handle: Aluminum  
Case: Iron

■ **911A**

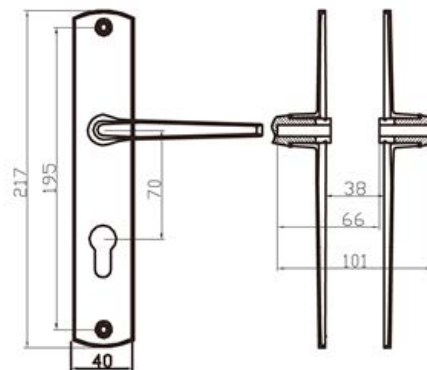

Handle: Aluminum  
Case: Zinc Alloy

■ **802**

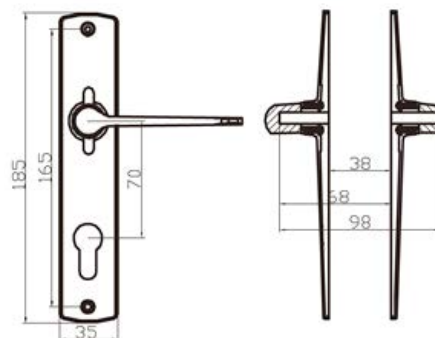

Handle: Zinc Alloy  
Case: Iron

■ 1998

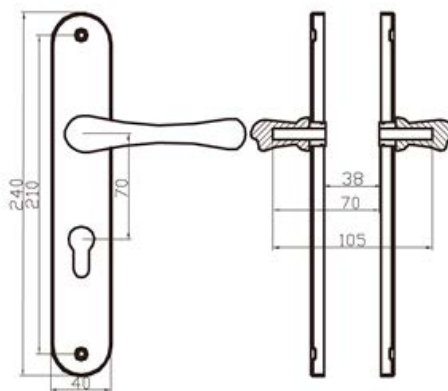

Handle: Aluminum  
Case: Iron

■ H301-C'B'K

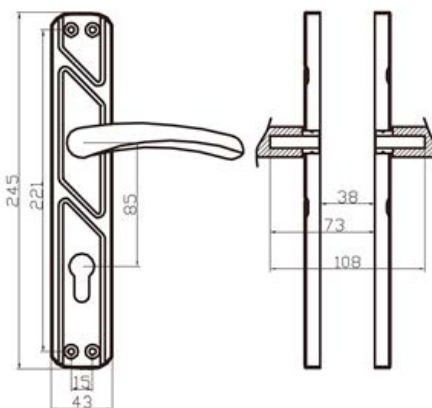

Handle: Aluminum  
Case: Iron

■ M18

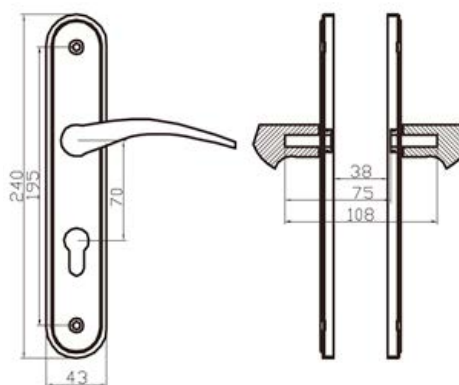

Handle: Aluminum  
Case: Iron

■ M03

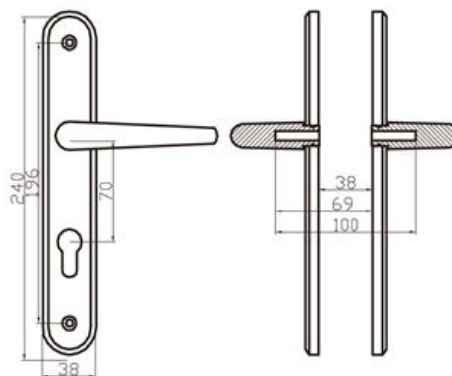

Handle: Aluminum  
Case: Iron

■ 301

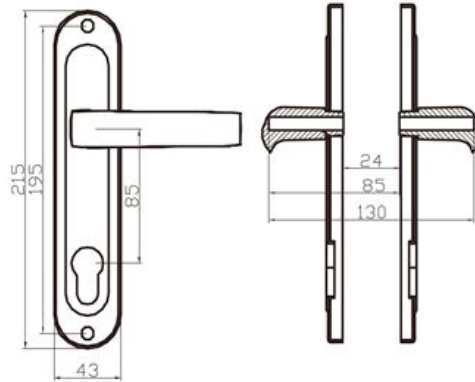

Handle: Zinc Alloy  
Case: Iron

■ 303

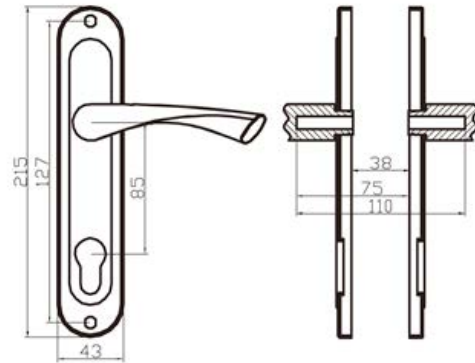

Handle: Zinc Alloy  
Case: Iron

■ P3

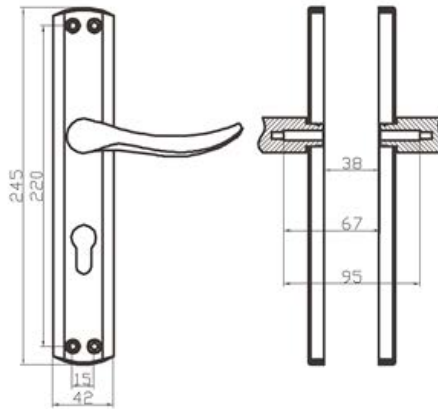

Handle: Aluminum  
Case: Iron

■ H301

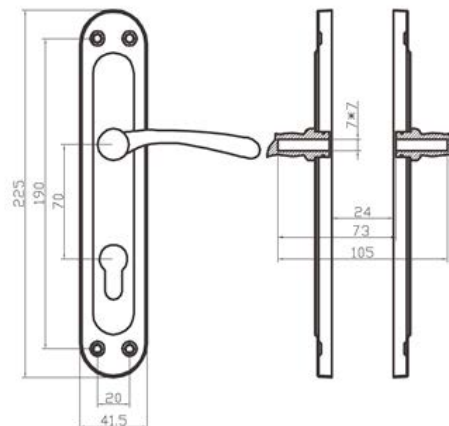

Handle: Aluminum  
Case: Iron

■ 113

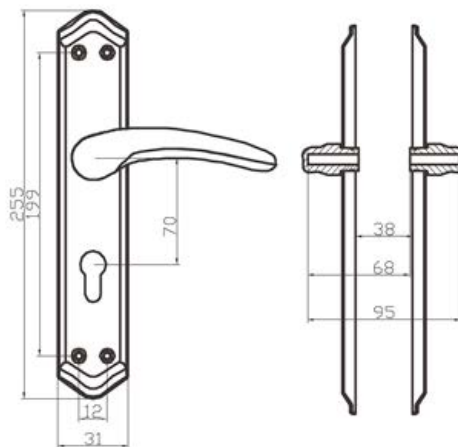

Handle: Aluminum  
Case: Iron

■ 116

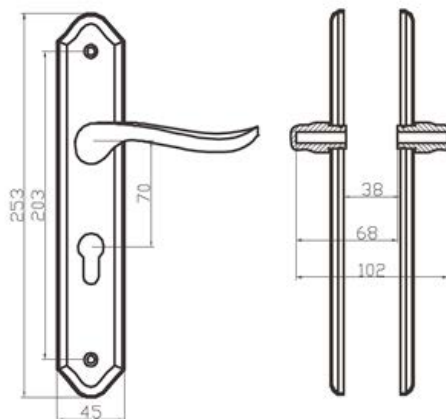

Handle: Aluminum  
Case: Iron

■ 302

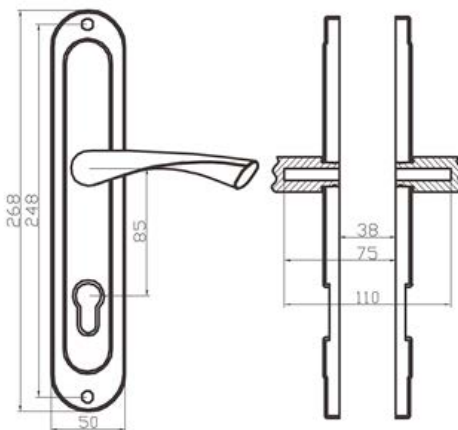

Handle: Zinc Alloy  
Case: Iron

■ 262

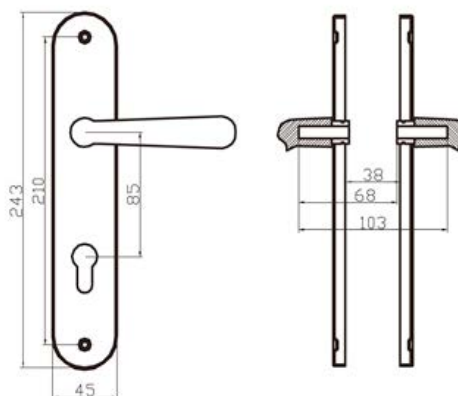

Handle: Aluminum  
Case: Iron

■ 994-1

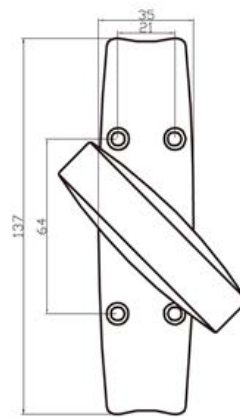

Handle: Aluminum  
Case: Iron

■ 994-2

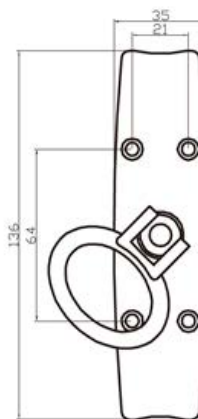

Handle: Aluminum  
Case: Iron

■ CRE-6

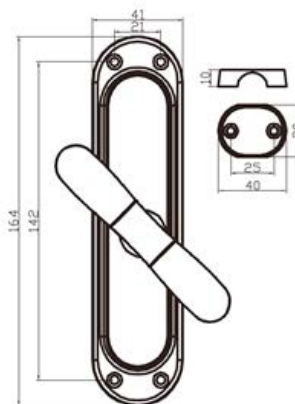

Handle: Zinc Alloy  
Case: Zinc Alloy

■ 446

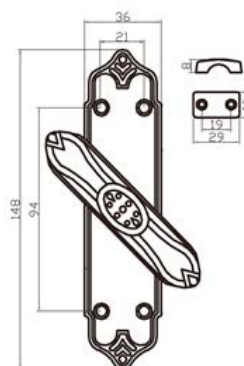

Handle: Zinc Alloy  
Case: Zinc Alloy



■ 988-1

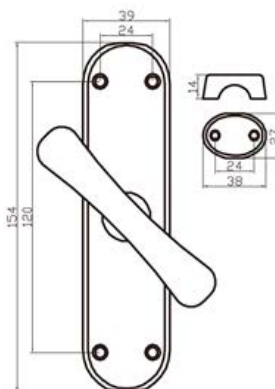

Handle: Aluminum  
Case: Iron

■ 988-2

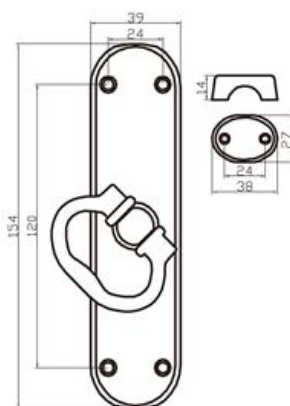

Handle: Zinc Alloy  
Case: Iron

■ 997-1

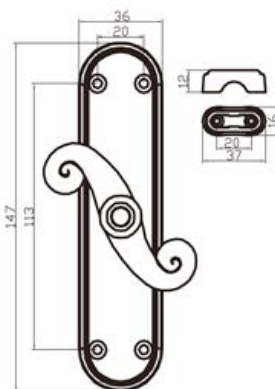

Handle: Zinc Alloy  
Case: Zinc Alloy

■ 997-2

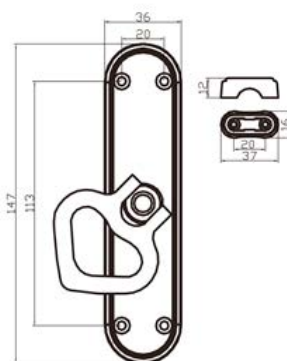

Handle: Zinc Alloy  
Case: Zinc Alloy

■ 3032

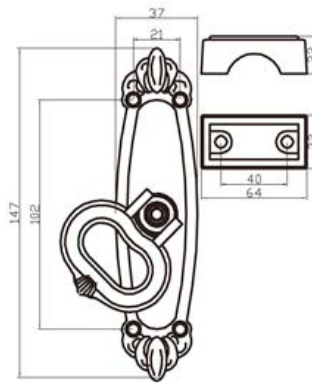

Handle: Zinc Alloy  
Case: Zinc Alloy

■ 3034

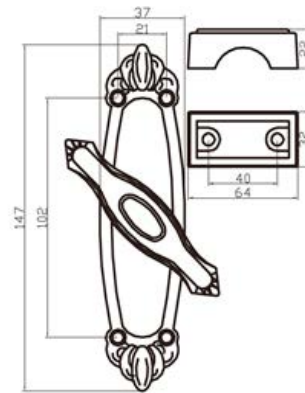

Handle: Zinc Alloy  
Case: Zinc Alloy



■ 1549-A



■ 1549-B



■ 1549-C



■ 1549-D



■ 1549-E



■ 1549-F



■ 1549-G



■ 716-M18K



■ 9040B-9114B



■ 9040B-911AB



■ 113



■ PAH-01



■ 368



L	50	60	70	80	100	120
---	----	----	----	----	-----	-----

■ AXF80

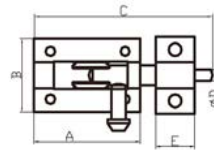

A	70	80	100	120
B	65	65	65	65
C	110	130	150	185
D	14	14	14	14
E	25	25	25	25

■ ZX

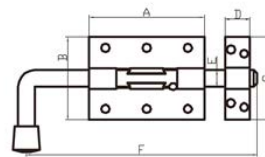

A	10	12	14	16	18
B	70	80	90	100	100
C	50	55	60	65	70
D	15	20	25	30	30
E	10	12	14	16	18
F	140	150	160	170	180

■ LX140'160



A	160	200	250	300	400	500	600
B	16						

A	160	200	250	300
B	14			

■ ALX

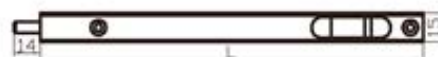

L	110	150	200	250	300
---	-----	-----	-----	-----	-----

■ 252RL 装饰圈

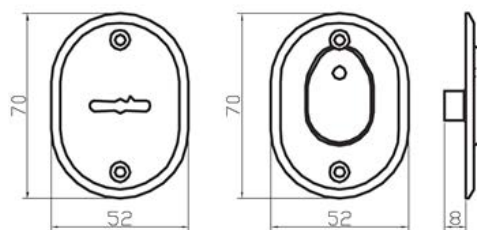

■ 016K'C

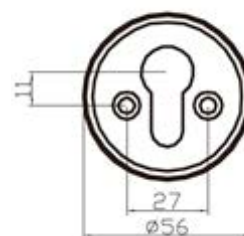

■ 027



■ 0350P



■ **4330 & 4325-A**



Height: 4 Inch  
Width: 3 Inch  
Thickness: 2.2/2.7 mm  
Material: Stainless Steel

■ **4330 & 4325-B**



Height: 4 Inch  
Width: 3 Inch  
Thickness: 2.2/2.7 mm  
Material: Stainless Steel

■ **4330 & 4325-C**



Height: 4 Inch  
Width: 3 Inch  
Thickness: 2.2/2.7 mm  
Material: Stainless Steel

■ **Hydraulic Hinge 803**





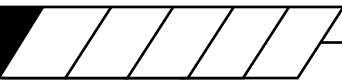

■ 002



■ 602



■ 605



■ 806



■ HDS1





- We have **2** overseas offices located in German and American.
- Products are exported to more than **80** countries.
- More than **500** types of locks for your choice.



Our Factory is based in Jiangsu Suzhou

**Web:** [www.cmeclock.com](http://www.cmeclock.com)

**TEL:** +86-512-65323291

**E-mail:** [info@cmeclock.com](mailto:info@cmeclock.com), [gushiqing@cmecsz.com](mailto:gushiqing@cmecsz.com)

**Address:** 659# Jinmen Road, Suzhou, Jiangsu, China

Wechat: Leon Gu